

1 Unpack

Boxed Parts

- Please read the hints and tips below to help you with the application of your cable management.**
- i** Ensure you roll wall strip **A** and cover strip **B** smoothly and evenly to prevent creasing.
 - ii** Ensure both wall strip **A** and cover strip **B** are as flat as possible before attaching to the wall.
 - iii** Ensure the surface you wish to attach the cable management to is clean and dry.
 - iv** Ensure that before you attach wall strip **A** you are happy with the position.
 - v** Ensure when you attach wall strip **A** to the wall that you press firmly and that you remove all air bubbles, repeat after 5 minutes.

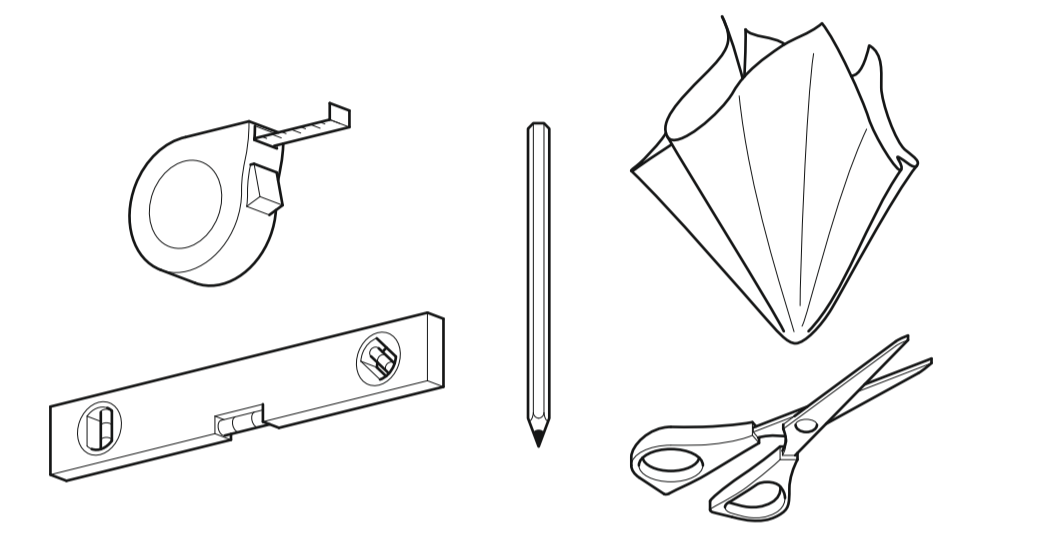

Tools Recommended

5 Attaching Cover Strip B

Lightbulb icon: You can tie a piece of string around your cables at the top and bottom to make it easier to attach cover front strip **B**.

i

With cables in place, hook one side of cover strip **B** into wall strip **A**.

ii

Working from the top, squeeze cover strip **B** so the other side hooks into place.

iii

With the top of cover strip **B** in place you will be able to hook the rest of cover strip **B** into place by firmly squeezing and sliding your thumb downwards.

6 Finishing Touch

Paintbrush icon: If you desire you can paint your cable management to suit your decor for an even more stylish, low key finish.

JZA200

Leaflet No. 463438 rev01

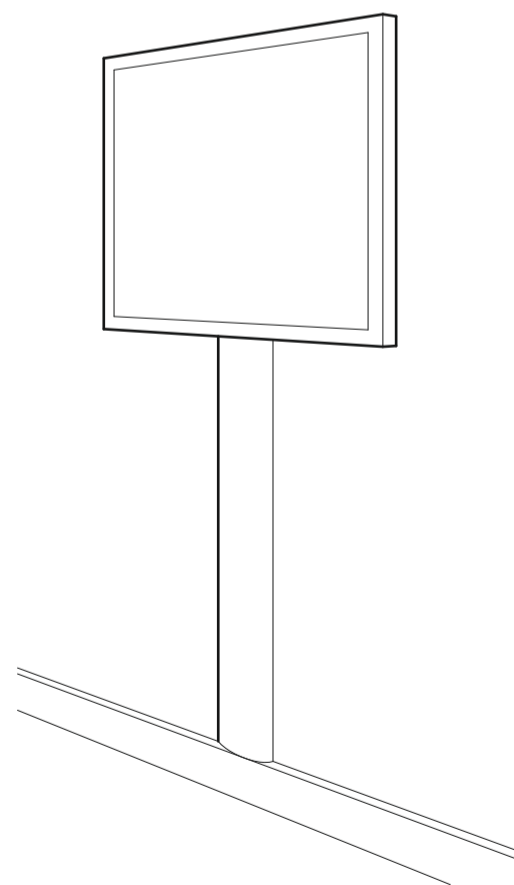

STOP Read through **ALL** instructions before commencing installation. If you have any questions about this product or issues with installation contact the customer services helpline before returning this product to the store. See jl.avfgroup.com/p/jza200 for more information.

CUSTOMER SERVICES HELP LINE NUMBER:
01952 670009

2 Uncurling and Flattening



Be careful not to crease, roll smoothly and evenly.

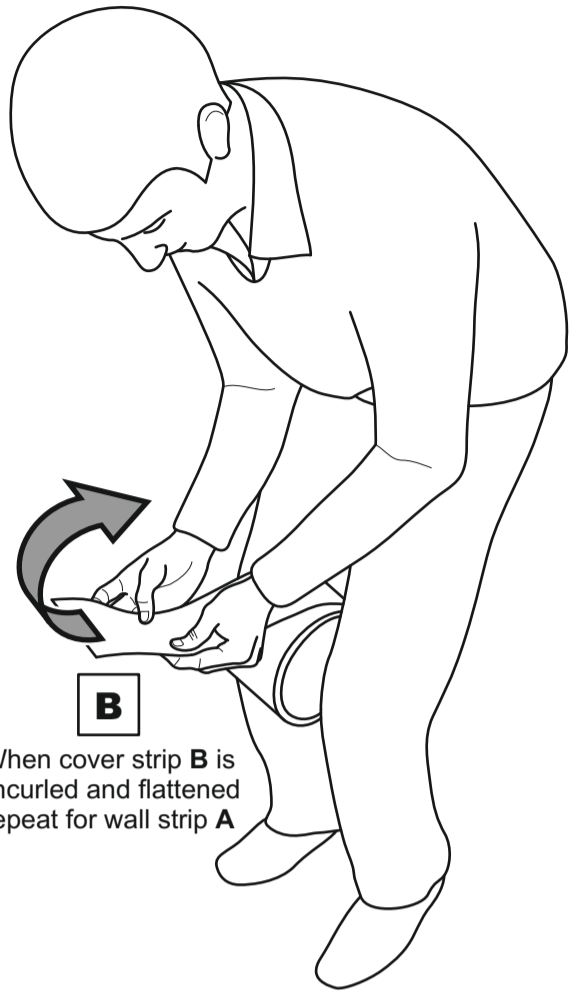

B
When cover strip **B** is uncurled and flattened repeat for wall strip **A**

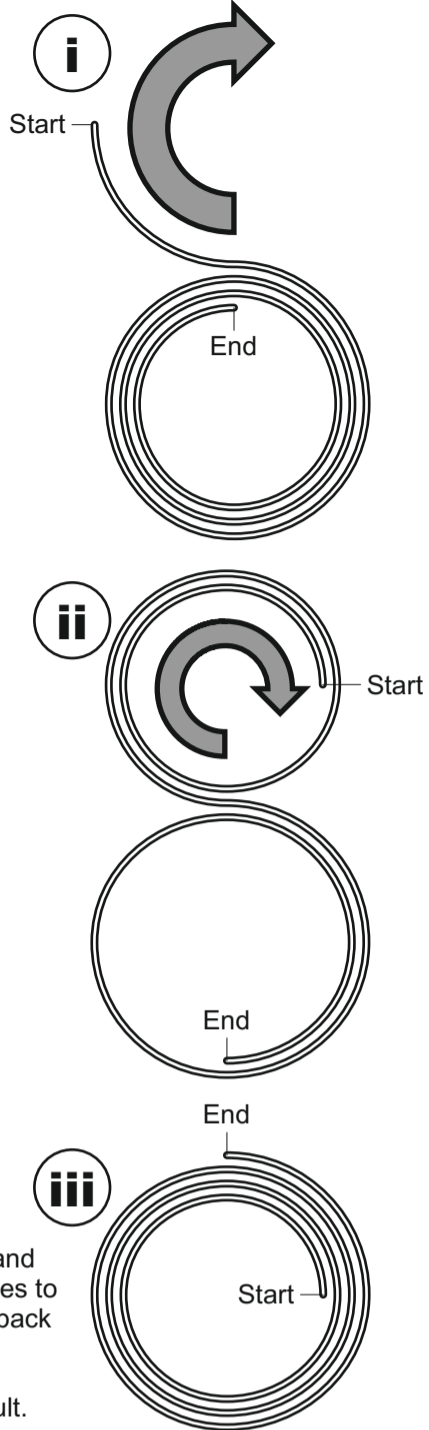

When uncurling and flattening wall strip **A** and cover strip **B**, put the roll between your knees to keep the roll steady while you roll the strip back on itself. We recommend this action is performed a minimum of 3 times to get the required result.

3 Measuring and Cutting

Measure and cut wall strip **A** and cover strip **B**

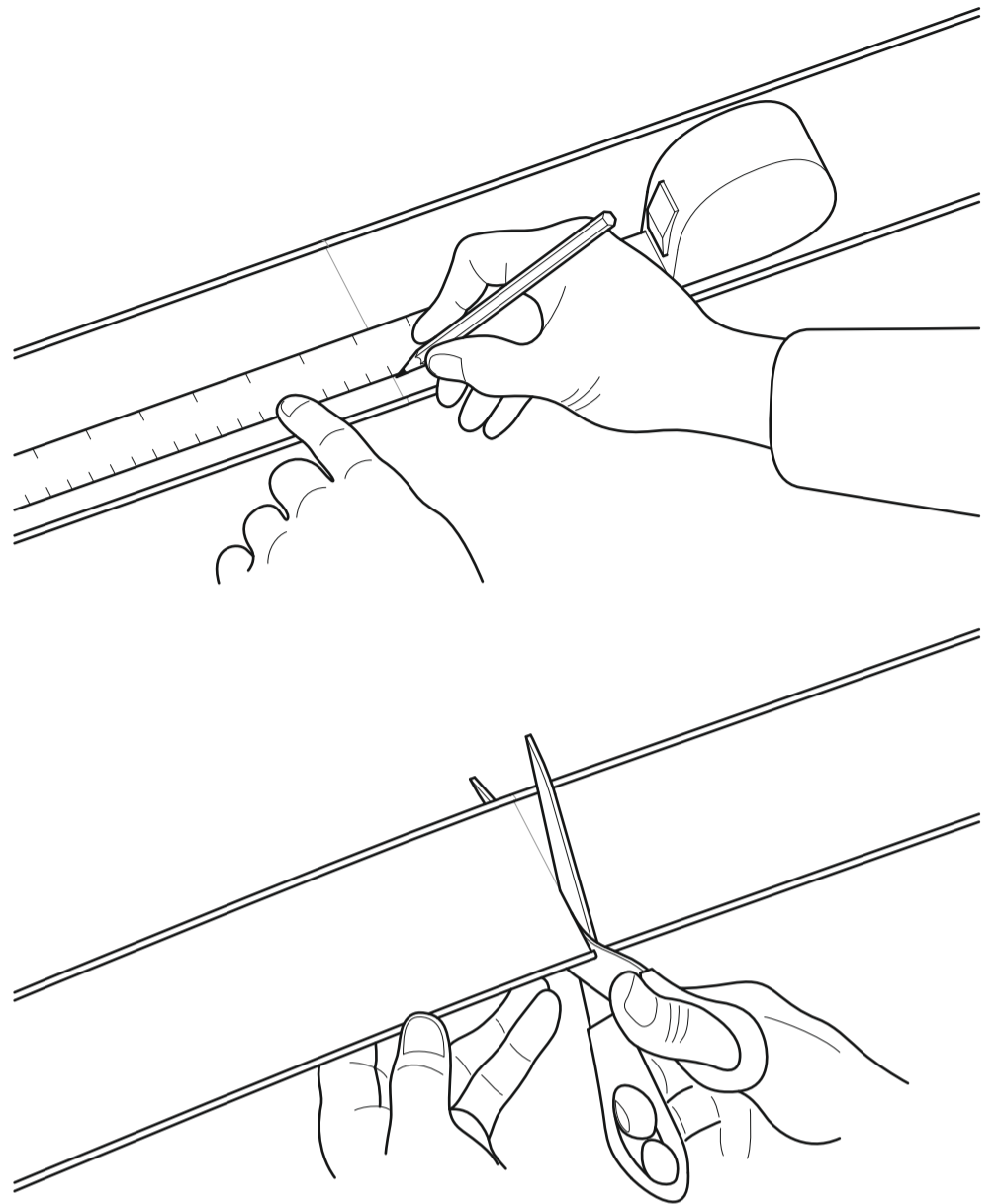

4 Attaching Wall Strip A



Before you attach wall strip **A**, make sure you are happy with the position

i

Before you attach wall strip **A**, use a clean, slightly damp cloth to clean the surface, let it dry thoroughly. Failure to do this will result in poor attachment.

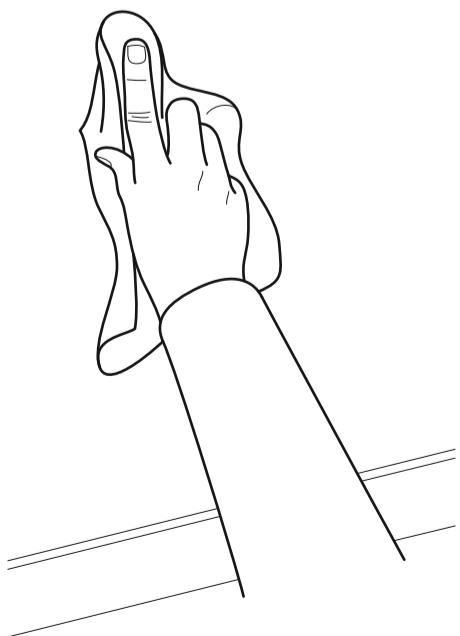

ii

Remove backing paper from the self adhesive strips on wall strip **A**.

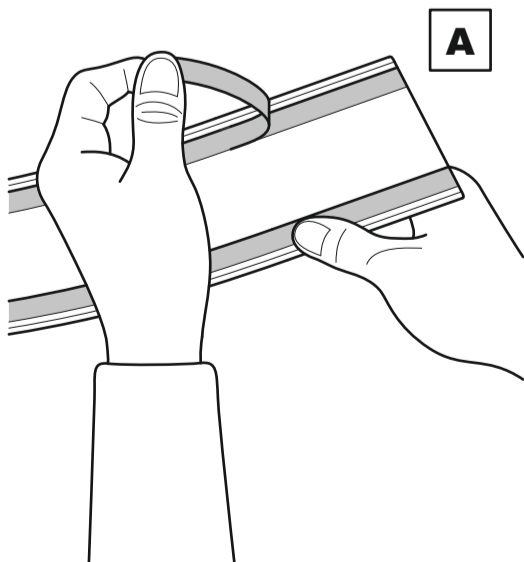

iii

Using a spirit level as a guide, carefully stick wall strip **A** to the wall.

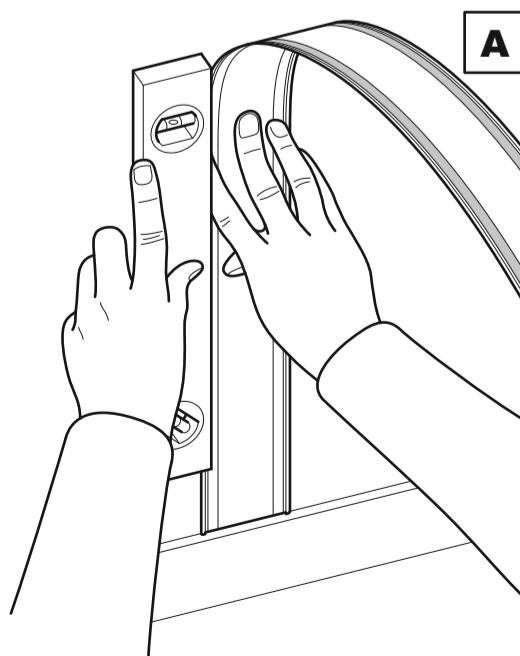

iv

Using a clean, dry cloth firmly press and rub up and down in the channels to ensure all air bubbles have been removed from wall strip **A**. Repeat after 5 minutes to ensure wall strip **A** is firmly attached to the wall.

