



Dreamland

**INTELLIHEAT
FAUX FUR HEATED
MATTRESS PROTECTOR**

**TYPE N3901
N3903
N3907**



Operating instructions

ILLUSTRATIVE GUIDE

[A]

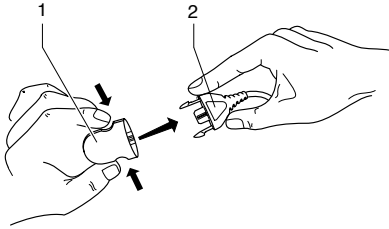

Attaching the connector

[B]

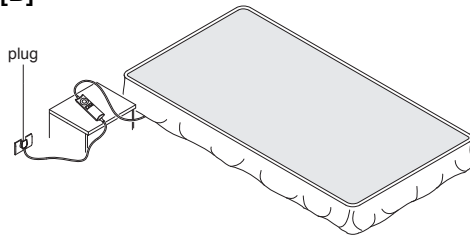

Fitting your mattress protector to the mattress

[C]

- 3. LED DISPLAY
- 4. 1 - 5 ALL NIGHT USE TEMPERATURE SETTINGS
- 5. FAST PRE-HEAT SETTING, READY FOR BED IN 5 MINUTES
- 6. TIMER DISPLAY 1 HOUR OR 9 HOURS
- 7. TIMER/STANDBY BUTTON
- 8. READY FOR BED FAST PRE-HEAT BUTTON
- 9. TEMPERATURE BUTTON
- 10. STANDBY DISPLAY
- 11. ON/OFF SWITCH

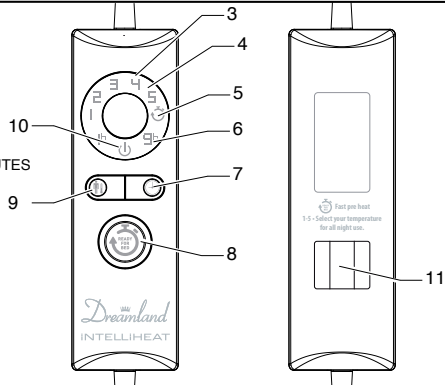

[D]

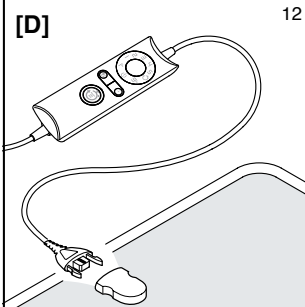

Check control for wear + tear

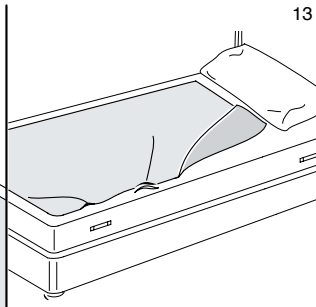

Do not use if rucked or creased

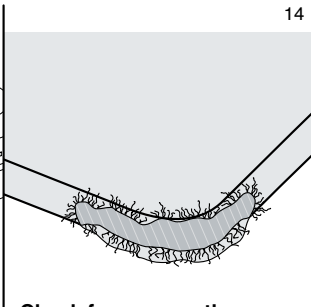

Check for wear on the blanket and do not use if frayed



INTRODUCTION

EN

Dear customer, thank you for choosing our product. We feel certain you will appreciate its quality and reliability as it was designed and manufactured with customer satisfaction in mind. These instructions for use comply with the European Standard EN 82079.

IMPORTANT INSTRUCTIONS. RETAIN FOR FUTURE USE.



ATTENTION! Instructions and warnings for a safe use.



Before using this appliance, carefully read the instructions for use and in particular the safety notes and warnings, which must be complied with. Keep this manual together with its illustrative guide for future consultation. Should you transfer the appliance to another user, make sure you hand over this documentation as well.

NOTE: should any part of this manual be difficult to understand or any doubt arise, contact the company at the address indicated on the last page before using the product.

NOTE: Partially sighted persons can consult the digital version of these instructions for use on the website www.dreamlanduk.co.uk

INDEX

| | | | |
|--|--------|--|--------|
| Introduction | Page 1 | Storing the electric blanket | Page 7 |
| Safety notes | Page 1 | Trouble shooting | Page 7 |
| Symbols | Page 4 | Disposal | Page 7 |
| Description of the appliance | Page 4 | Warranty | Page 8 |
| Positioning and fitting instructions | Page 4 | Illustrative guide | I |
| Using your blanket | Page 5 | Technical data | II |
| Cleaning and Maintenance | Page 6 | | |

SAFETY NOTES

- After unpacking, make sure the appliance is intact, complete with all its parts as shown in the illustrative guide and with no sign of damage due to transportation. In doubt, do not use the appliance and contact an authorised service centre.



EN



WARNING! Risk of suffocation.

Children shall not play with the packaging. Keep the plastic bag out of the reach of children.





- This appliance must be used only for the purpose for which it was designed, as a mattress protector for home use. Any other use is considered not compliant with the intended use and therefore dangerous.
- Before connecting the appliance to the mains supply, make sure that the voltage and frequency indicated on the technical data of the appliance correspond to those of the mains supply. The rating is on the appliance or on the power supply unit, if any (see illustrative guide).
- If the appliance is provided with a voltage/frequency selector, set the selector correctly to comply with the mains supply parameters.
- This appliance is only to be used with the types of detachable control unit that are marked on the appliance.



Children under the age of three are not to use this appliance due to their inability to react to overheating.

- This appliance can be used by children older than 3 years and younger than 8 years under supervision and with the control always set to minimum temperature.
- This appliance can be used by children aged from 8 years and above and persons with reduced physical, sensory or mental capabilities or lack of experience and knowledge if they have been given supervision or instruction concerning use of the appliance in a safe way and understand the hazards involved. Children shall not play with the appliance. Cleaning and user maintenance shall not be made by children without supervision.
- This appliance must not be used by persons insensitive to heat and other very vulnerable persons who are unable to react to overheating.
- **DO NOT** use the appliance with wet hands or damp feet.
- **DO NOT** pull the supply cord or the appliance itself to remove the plug from the socket.
- **DO NOT** pull or lift the appliance by the supply cord.



- The cable and control unit of the appliance can give rise to risks of entanglement, strangulation, tripping or treading if not correctly arranged. The user shall make sure that electric cords shall be arranged in a safe way.
-  DO NOT expose the appliance to humidity or atmospheric agents (rain, sun, etc.) or extreme temperatures.
- Always disconnect the appliance from the mains supply before cleaning or performing maintenance and when the appliance is not in use.
- Examine the appliance frequently for signs of wear or damage. If there are such signs, if the appliance has been misused or does not work, contact an authorised technical service centre before switching it on again.
- If the appliance is faulty or malfunctions, switch it off and do not tamper with it. Contact an authorised technical service centre for any repairs.
- If the supply cord is damaged, take the whole appliance to an authorised technical service centre for the replacement of the control unit , so as to prevent all risks.
-  DO NOT use this appliance to warm animals.
-  DO NOT place the control unit under the pillow or between the sheets or blankets.
- If the appliance is used on an adjustable bed, check that the blanket and cord do not become trapped or rucked, for example in hinges.
-  DO NOT tuck in.
- This appliance is not intended for medical use in hospitals.
-  DO NOT use if wet.



DO NOT USE FOLDED OR CREASED.















DO NOT INSERT PINS OR NEEDLES.

- For the features of the appliance, refer to the external packaging.
- Use the appliance only with the supplied accessories that are an essential part of the appliance.



SYMBOLS

| | | | |
|---|--|---|---|
|  | <i>Protection class II</i> |  | <i>Prohibited actions</i> |
|  | <i>Carefully read the operating instructions</i> |  | <i>Important note</i> |
|  | <i>Warning</i> |  | <i>Children under 3 years old not allowed</i> |
|  | <i>Do not use folded or creased</i> |  | <i>Do not insert pins or needles</i> |
|  | <i>Wash at maximum 40° C on a wool programme</i> |  | <i>Do not bleach</i> |
|  | <i>Tumble dry, low heat</i> |  | <i>Do not dry clean</i> |
|  | <i>Do not iron</i> | | |

DESCRIPTION OF THE APPLIANCE

Refer to the illustrative drawing at the beginning of this instructions booklet to verify your appliance equipment.

- | | |
|---|---------------------------------------|
| 1. Blanket connector | 7. Timer/standby button |
| 2. Control connector | 8. Ready for bed fast pre-heat button |
| 3. Led display | 9. Temperature button |
| 4. 1-5 All night use temperature settings | 10. Standby display |
| 5. Fast pre-heat setting - Ready for Bed in 5 minutes | 11. On/off switch |
| 6. Timer display 1 hour or 9 hours | |

POSITIONING AND FITTING INSTRUCTIONS



WARNING! The electric blanket must only be placed between the mattress and the flat sheet and not on top of persons in bed.

POSITIONING THE MATTRESS PROTECTOR (DIAGRAM B)

Place the fitted mattress protector directly onto the mattress. Fit the blanket to the mattress and turn the edges of the skirt under the mattress. (diagram [B])

Cover with a top sheet and duvet.

FITTING INSTRUCTIONS

Join the connector(s) (2) of the control unit to the connector (1) on the blanket. Ensure the connector is pushed home until the locking catch engages. (diagram [A]).

USING YOUR MATTRESS PROTECTOR



WARNING! DO NOT use this appliance if there are visible signs of damage.

EN



WARNING! NOT suitable for children under the age of 3.

Your Dreamland Intelliheat mattress protector is designed to FAST PREHEAT your bed and it also responds to temperature changes while you sleep.

IMPORTANT: The time required to heat the electric blanket may vary depending on the room temperature. To judge the temperature accurately, lie in the bed with the covers draped over you. Do not rely on a hand placed on the bed.



WARNING! This appliance is only to be used with the control unit supplied with it. The reference of the control unit is specified on the label sewn onto the appliance.



WARNING! DO NOT place the control unit under the pillow or under the sheets when in use.

Connect the control connector into the blanket socket then plug into the mains socket.

Switch on your Intelliheat blanket from the back of the control (11) Diagram [C], by positioning the switch ON (I). The temperature setting (4) Diagram [C] will default to the last one used, providing it has been set to that number for a period longer than 5 minutes.

TO HEAT UP YOUR INTELLIHEAT MATTRESS PROTECTOR, YOU MUST ALWAYS PRESS THE READY FOR BED FAST PREHEAT BUTTON. DO NOT GET INTO BED WITH YOUR BLANKET ON THE READY FOR BED FAST PREHEAT TEMPERATURE SETTING.

READY FOR BED FAST PREHEAT: Press the Ready for Bed, fast pre-heat button on the front of the control (8) Diagram [C]. The setting (5) (Diagram C) will be illuminated in red on your LED Display (3) (Diagram C). Your blanket will be lovely and warm in just 5 minutes.

TO SET FOR ALL NIGHT USE: RELEASE the Ready for Bed fast pre-heat button, and press the temperature button (9) Diagram [C] to select your preferred all night temperature setting from 1 (min) to 5 (max). The higher the number, the higher the temperature. This will be illuminated in orange on the (3) LED display (4) (Diagram C).

1 OR 9 HOURS AUTO SHUT OFF TIMER: The Intelliheat control has an AUTOMATIC SHUT OFF TIMER. To set the timer, press the timer button (7) Diagram [C] and select either 1h or 9h. This will be illuminated in green on the (3) LED Display (6) Diagram [C].

TIMER OFF/STANDBY: When the set time period has elapsed, the blanket will automatically switch off and the standby light will be illuminated in blue on the (3) LED display (10) Diagram [C]. If you wish to switch your blanket back on again, press the timer button (7) Diagram [C] selecting either 1 or 9 hours.

MANUAL SWITCH OFF BOTH BLANKET AND CONTROL: Switch off the back of your Intelliheat control (11) Diagram [C] to off (O) position.

MEMORY FUNCTION: After using your blanket for more than 5 minutes, the Intelliheat control will remember your last temperature setting.

DISCONNECT: To disconnect your electric blanket from the mains socket, switch the control to OFF position on the back of your Intelliheat control (O) (11) (Diagram [C]), and then safely disconnect the plug from the mains socket.

CLEANING AND MAINTENANCE

Your mattress protector is suitable for washing. Check the washing instructions on the label of your mattress protector to wash it correctly.



WARNING! Always disconnect the appliance from the mains supply before cleaning or performing maintenance.

BEFORE WASHING OR STORING YOUR MATTRESS PROTECTOR:

1. Disconnect the control from the mains socket.
2. Disconnect the connector (2) from the mattress protector by pressing the push buttons at the sides of the control connector (1).
3. Ensure that the controls are not connected and none of the wires have worn through the fabric.
4. It is important to measure the mattress protector before washing and check that the dimensions are approximately the same before drying.



MACHINE WASHING

- The mattress protector can be machine washed at 40°C on a wool programme.
- Only the gentle spin cycle is to be used. DO NOT use an extra spin cycle.



TUMBLE DRYING

- Tumble dry at a low temperature.
- DO NOT use the mattress protector until it is completely dry.

HANGING THE MATTRESS PROTECTOR OUTSIDE TO DRY

- The mattress protector must be stretched back to approximately its original size during the drying process. This is best done whilst damp, working from side to side, stretching a piece at a time. This procedure may need to be repeated a few times until fully dry.
- Make sure the wires are not kinked or twisted. It is easier to check the wires by placing the mattress protector against the light.
- If problems arise with the wires after having dried the mattress protector or if it does not return to its original size, return it to our authorised Service Centre for a safety check.



WARNING! Examine the appliance against the light to make sure the cables are not bent or twisted.



WARNING! If the appliance does not resume its original size or if problems arise with the internal cables contact an authorised service centre for a safety check.



WARNING! Hang the appliance without applying pegs so as not to damage it.



STORING THE MATTRESS PROTECTOR

When not in use, store as follows:

When storing the appliance, allow it to cool down before folding.

- Make sure your mattress protector is dry if it has been washed.
- Fold your mattress protector as a normal blanket.
- It is recommended to store the mattress protector in the bag it was purchased in.
- Store the mattress protector in a dry place.



WARNING! DO NOT crease the appliance by placing items on top of it during storage.

The fabric may take on a natural yellow colour over time. This does not compromise the safety and/or performance of the product in any way.

Examine the appliance and its supply cord frequently for signs of wear or damage. If there are such signs or in the case of malfunction, contact an authorised technical service centre.

TROUBLE SHOOTING

This appliance is built to the very highest of standards. Follow the trouble shooting guide if the unit fails to operate. If you don't find any solution, discontinue use and return it to our Service Centre for a Safety inspection.

| Problem | Solution |
|---|---|
| You feel a tingling sensation while in use. | This can be quite common and is completely harmless. Contact the after sales service for further information. |
| Damage to the control unit Diagram [D] 12 Page I. | Discontinue use and return it to our Service Centre for a safety inspection. |
| Fabric rucking or creasing Diagram [D] 13 Page I. | |
| Wear or tear on the fabric Diagram [D] 14 Page I. | |
| Heat discoloration of fabric. | |
| The product has been misused or accidentally damaged. | |

DISPOSAL



The packaging of the appliance is made of recyclable materials. Dispose of it in accordance with the environmental protection regulations.



Pursuant to Directive 2012/19/EU on waste electrical and electronic equipment (WEEE), the crossed bin symbol on the appliance or its packaging indicates that the appliance must be disposed of separately from other waste at the end of its useful life.

The user must therefore take the appliance to an appropriate recycling centre for electrical





EN

and electronic equipment. Alternatively, instead of handling the disposal, the user can hand over the appliance to the retailer when a new, equivalent one is purchased. The user can hand over electronic products measuring less than 25 cm to retailers of electronic products having a sales area of at least 400 m² free of charge and with no obligation to buy. Appropriate separate collection for the subsequent procedure for the decommissioned appliance for recycling, which includes treatment and environmentally friendly disposal helps prevent adverse effects on the environment and health and promotes reusing and/or recycling materials that the appliance consists of.

WARRANTY

This product is guaranteed for a period of 3 years from the date of purchase against material, mechanical and electrical defects. The warranty is binding if it is accompanied by a valid receipt of payment. This guarantee is only valid if the appliance is used solely for domestic purposes in accordance with the instructions provided that is not connected to an unsuitable electricity supply, dismantled, interfered with in any way damaged, through misuse, fair wear and tear. Under this guarantee we undertake to repair or replace free of charge any parts found to be defective.

PLEASE NOTE, THE COST OF A SAFETY INSPECTION IS NOT COVERED BY THIS GUARANTEE. A CHARGE WILL BE MADE IN RESPECT OF ANY PRODUCT RETURNED UNDER THIS GUARANTEE, WHERE NO FAULT IS FOUND.

This guarantee is offered as an extra benefit and does not affect your statutory rights as a consumer. This guarantee does not confer any rights other than those expressly set out above and in particular we shall not be liable for any indirect or consequential loss or damage. Nothing in this guarantee or the instructions relating to the product excludes, restricts or otherwise affects your statutory rights. In line with our policy of continuous development, we reserve the right to change this product, packaging and documentation without notice. If a defect appears and after checking that the blanket is being used properly in accordance with the instructions, return it with a valid proof of purchase, as soon as possible to the manufacturer's Service Centre. This guarantee is valid in the UK only.

SERVICE CENTRE





PO Box 166 – Middlewich – Cheshire – CW 10 0ZU - Tel: **0333 0050305**









E-mail: customerservice@imetec.co.uk

www.dreamlanduk.co.uk





TECHNICAL DATA









Dreamland **UNDERBLANKET**
TYPE N3901 220-240 V 50/60 Hz 2x85 W





        









Dreamland **UNDERBLANKET**
TYPE N3903 220-240 V 50/60 Hz 100 W

Dreamland **UNDERBLANKET**
TYPE N3907 220-240 V 50/60 Hz 140 W



Dreamland

M1002685
100317

