



## CONTENTS

1. SAFETY INFORMATION.....	3
2. SAFETY INSTRUCTIONS.....	5
3. PRODUCT DESCRIPTION.....	7
4. CONTROL PANEL.....	8
5. PROGRAMMES .....	12
6. CONSUMPTION VALUES.....	16
7. SETTINGS.....	17
8. OPTIONS.....	17
9. BEFORE FIRST USE.....	19
10. DAILY USE - WASHING ONLY.....	20
11. DAILY USE - DRYING.....	23
12. DAILY USE - WASHING & DRYING.....	24
13. HINTS AND TIPS.....	26
14. CARE AND CLEANING.....	27
15. TROUBLESHOOTING.....	33
16. INSTALLATION.....	37
17. TECHNICAL DATA.....	43

## FOR PERFECT RESULTS

Thank you for choosing this AEG product. We have created it to give you impeccable performance for many years, with innovative technologies that help make life simpler features you might not find on ordinary appliances. Please spend a few minutes reading to get the very best from it.

**Visit our website for:**



Get usage advice, brochures, trouble shooter, service information:  
**[www.aeg.com](http://www.aeg.com)**



Register your product for better service:  
**[www.registeraeg.com](http://www.registeraeg.com)**



Buy Accessories, Consumables and Original spare parts for your appliance:  
**[www.aeg.com/shop](http://www.aeg.com/shop)**

## CUSTOMER CARE AND SERVICE

Always use original spare parts.

When contacting our Authorised Service Centre, ensure that you have the following data available: Model, PNC, Serial Number.

The information can be found on the rating plate.



Warning / Caution-Safety information



General information and tips



Environmental information

Subject to change without notice.

# 1. ⚠ SAFETY INFORMATION

Before the installation and use of the appliance, carefully read the supplied instructions. The manufacturer is not responsible if an incorrect installation and use causes injuries and damages. Always keep the instructions with the appliance for future reference.

## 1.1 Children and vulnerable people safety



### WARNING!

Risk of suffocation, injury or permanent disability.

- This appliance can be used by children aged from 8 years and above and persons with reduced physical, sensory or mental capabilities or lack of experience and knowledge if they have been given supervision or instruction concerning use of the appliance in a safe way and understand the hazards involved.
- Do not let children play with the appliance.
- Children of less than 3 years should be kept away unless continuously supervised.
- Keep all packaging away from children.
- Keep all detergents away from children.
- Keep children and pets away from the appliance door when it is open.
- If the appliance has a child safety device, we recommend you activate it.
- Cleaning and user maintenance shall not be made by children without supervision.

## 1.2 General Safety

- Do not change the specification of this appliance.
- The appliance can be installed as freestanding or below the kitchen counter with correct space.
- Do not install the appliance behind a lockable door, a sliding door or a door with a hinge on the opposite

side, where the appliance door can not be fully opened.

- Connect the mains plug to the mains socket only at the end of the installation. Make sure that there is access to the mains plug after the installation.
- The ventilation openings in the base (if applicable) must not be obstructed by a carpet.
- Ensure you have good ventilation in the installation room to avoid the back flow of gases into the room from appliances burning other fuels, including open fires.
- Exhaust air must not be discharged into a flue which is used for exhausting fumes from appliances burning gas or other fuels (if applicable).
- The operating water pressure (minimum and maximum) must be between 0,5 bar (0,05 MPa) and 8 bar (0,8 MPa).
- Obey the maximum load volume of 9 kg (refer to the "Programme chart" chapter).
- The appliance is to be connected to the water mains using the new supplied hose-sets. Old hose sets must not be reused.
- If the supply cord is damaged, it must be replaced by the manufacturer, its Authorised Service Centre or similarly qualified persons in order to avoid a hazard.
- Wipe away lint that has accumulated around the appliance.
- Do not run the appliance without filters. Clean the lint filter before or after each use.
- Items that have been soiled with substances such as cooking oil, acetone, alcohol, petrol, kerosene, spot removers, turpentine, waxes and wax removers should be washed in hot water with an extra amount of detergent before being dried in the wash dryer.
- Do not use the appliance if industrial chemicals have been used for cleaning.
- Do not dry unwashed items in the wash dryer.

- Items such as foam rubber (latex foam), shower caps, waterproof textiles, rubber backed articles and clothes or pillows fitted with foam rubber pads should not be dried in the wash dryer.
- Fabric softeners, or similar products, should be used as specified by the fabric softener instructions.
- Remove all objects from pockets such as lighters and matches.
- Never stop the wash dryer before the end of the drying cycle unless all items are quickly removed and spread out so that the heat is dissipated.
- The final part of a wash dryer cycle occurs without heat (cool down cycle) to ensure that the items are left at a temperature that ensures that the items will not be damaged.
- Do not use water spray and steam to clean the appliance.
- Clean the appliance with a moist soft cloth. Only use neutral detergents. Do not use abrasive products, abrasive cleaning pads, solvents or metal objects.
- Before maintenance, deactivate the appliance and disconnect the mains plug from the mains socket.

## 2. SAFETY INSTRUCTIONS

### 2.1 Installation

- Remove all the packaging and the transit bolts.
- Keep the transit bolts. When you move the appliance again you must block the drum.
- Always be careful when you move the appliance because it is heavy. Always wear safety gloves.
- Do not install or use a damaged appliance.
- Obey the installation instruction supplied with the appliance.
- Do not install or use the appliance where the temperature is less than 0 °C or where it is exposed to the weather.
- Do not install or use the appliance where the temperature is less than 5°C or higher than 35 °C.
- Make sure that the floor where you install the appliance is flat, stable, heat resistant and clean.
- Do not install the appliance where the appliance door can not be fully opened.
- Always move the appliance vertically.
- The rear surface of the appliance must be put against the wall.
- Make sure that there is air circulation between the appliance and the floor.
- Adjust the feet to have the necessary space between the appliance and the carpet.
- When the appliance is put in its permanent position, check if it is fully

level with the aid of a spirit level. If it is not, adjust the feet until it is.

- To make sure the compressor works properly, wait 6 hours after the installation before using the appliance.

## 2.2 Electrical Connection



### WARNING!

Risk of fire and electrical shock.

- The appliance must be earthed.
- Always use a correctly installed shockproof socket.
- Do not use multi-plug adapters and extension cables.
- Do not pull the mains cable to disconnect the appliance. Always pull the mains plug.
- Do not touch the mains cable or the mains plug with wet hands.
- Only for UK and Ireland: The appliance has a 13 amp mains plug. If it is necessary to change the fuse in the mains plug, use a 13 amp ASTA (BS 1362) fuse.
- This appliance complies with the E.E.C. Directives.

## 2.3 Water Connection

- Make sure not to cause damage to the water hoses.
- Before you connect the appliance to new pipes or pipes not used for a long time, let the water flow until it is clean.
- The first time you use the appliance, make sure that there is no leakage.

## 2.4 Use



### WARNING!

Risk of injury, electrical shock, fire, burns or damage to the appliance.

- Use this appliance in a household only.
- Do not change the specification of this appliance.

- Do not put flammable products or items that are wet with flammable products in, near or on the appliance.
- Do not touch the glass of the door while a programme operates. The glass can be hot.
- Do not dry the damaged items which contain padding or fillings.
- If you have washed your laundry with a stain remover start an extra rinse cycle before you start the dryer.
- Make sure that you remove all metal objects from the laundry.
- Only dry fabrics which are applicable to dry in the tumble dryer. Follow the instructions on the fabric label.
- Plastic items are not heat resistant.
  - If you use a detergent ball, remove it before you set the drying programme.
  - Do not use a detergent ball when you set a non-stop programme.



### WARNING!

Risk of injury or damage to the appliance.

- Do not sit or stand on the open door.
- Do not dry dripping wet clothes in the appliance.

## 2.5 Disposal

- Disconnect the appliance from the mains supply.
- Cut off the mains cable and discard it.
- Remove the door catch to prevent children and pets to get closed in the appliance.

## 2.6 Compressor



### WARNING!

Risk of damage to the appliance.

- The compressor and its system in the washer-dryer is filled with the special agent which is free from fluorochlorohydrocarbons. This system must stay tight. The damage of the system can cause a leakage.

## 3. PRODUCT DESCRIPTION

### 3.1 Appliance overview

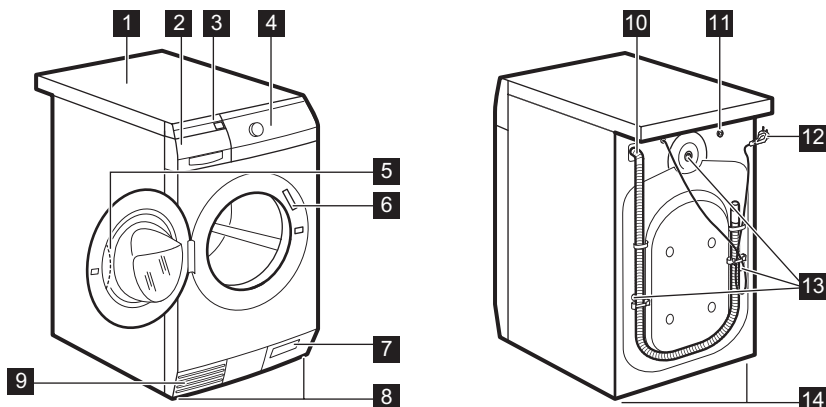

- 1** Worktop
- 2** Detergent dispenser
- 3** Air filter(s)
- 4** Control panel
- 5** Door handle
- 6** Rating plate
- 7** Drain pump filter
- 8** Feet for the appliance level
- 9** Airflow slots
- 10** Water drain hose
- 11** Water inlet valve
- 12** Mains cable
- 13** Transit bolts
- 14** Feet for the appliance level

### 3.2 How to activate the child safety device

This device prevents children or pets to be closed in the drum.

Turn the device clockwise, until the groove is horizontal.

You cannot close the door.

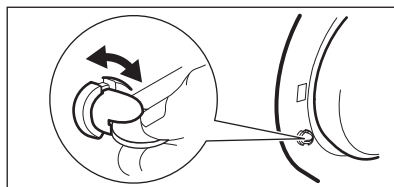

To close the door, turn the device anticlockwise until the groove is vertical.

### 3.3 Accessories

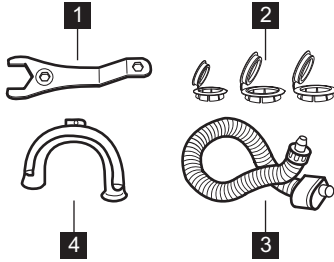

- 1 **Spanner**  
To remove the transit bolts.
- 2 **Plastic caps**  
To close the holes on the rear side of the cabinet after the removal of the transit bolts.
- 3 **Anti-flood inlet hose**  
To prevent possible leakage
- 4 **Plastic hose guide**  
To connect the drain hose on the edge of a sink.

## 4. CONTROL PANEL

### 4.1 Control panel description

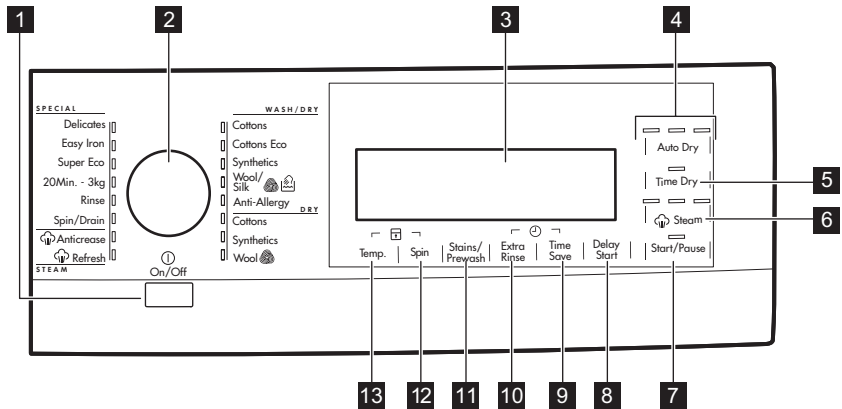

- 1 On/Off button (On/Off)
- 2 Programme knob
- 3 Display
- 4 Automatic drying level touch button (Auto Dry)
- 5 Drying time touch button (Time Dry)
- 6 Steam touch button (Steam)
- 7 Start/Pause touch button (Start/Pause)
- 8 Delay start touch button (Delay Start)
- 9 Time save touch button (Time Save)
- 10 Extra rinse touch button (Extra Rinse)
- 11 Option touch button (Stains/Prewash)
- 12 Spin reduction touch button (Spin)
- 13 Temperature touch button (Temp. °C)



## 4.2 Display

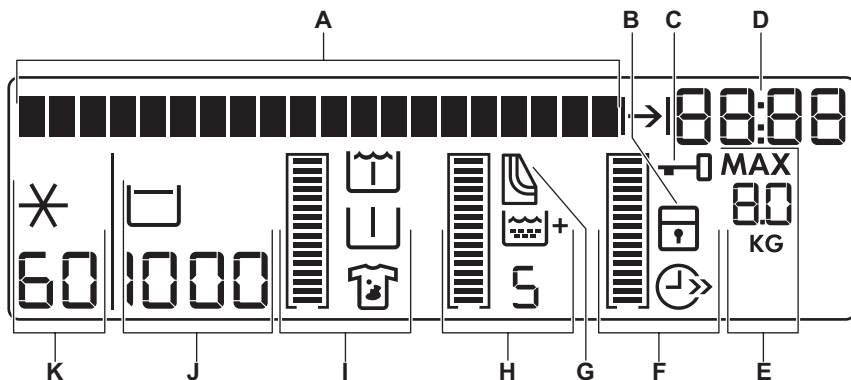



The display shows:

The text bar:

- A**
- Guides you in the use of the appliance.
  - Shows the programme status and phase.
  - Shows alarm messages. Refer to 'Troubleshooting'.

The symbols appear on the display when the related phase or function is set.

**B**  Child safety lock

**C**  Door locked

You cannot open the appliance door when the symbol is on. You can open the door only when the symbol goes off.

If the programme is completed but the symbol stays on:

- The «Rinse hold» function is on.
- There is water in the drum.

### Digit area

Time of the day

When you activate the appliance the display shows the time of the day for some seconds. To adjust the clock, refer to "Clock setting".

Programme duration

When you set the programme, the cycle duration is displayed for a few seconds then, the time of the programme end appears again.

**D**  Programme duration indicator  
The indicator comes on when the digits shows the programme duration.

End time of the programme

 Programme end indicator  
The indicator comes on when the digits shows the programme end time.

Time of delay

When you set the delayed start the time of the programme end increases by steps of 30 minutes till 10 hours and by steps of one hour till 20 hours.

End of the programme

The display shows a zero.

This part comes on only if the door is open - Refer to 'Activating the appliance and setting a programme'.

**E** **MAX**



Maximum allowed load of laundry for the set programme (in kg).

**KG**

### Graphic bars

To set a function:

The function indicator comes on when the related function is set.



















The empty indicator bar appears only if the related function is available for the set programme.  
If an indicator bar does not come on, it means that it is not available.



The indicator bar fills accordingly to the set functions.





If you make a wrong selection, the text bar says that the selection is not possible.

		Time save The indicator comes on when you set one of the programme duration.
F		Shortened time
		Extra Quick
G		Indicator for air filters
		Extra rinsing
H		The value shows the total number of the rinses.
		The indicator bar fills accordingly the numbers of rinses.
		Stain indicator
I		Prewash indicator
		Soak indicator
		The indicator bar fills accordingly to the set functions.
		Spin speed of the set programme
J		No Spin indicator <sup>1)</sup>
		Rinse Hold indicator
K		Default temperature of the set programme
		Cold water

<sup>1)</sup> Only available for SPIN/DRAIN programme.

## 5. PROGRAMMES

### 5.1 Programme Chart

Programme Temperature range	Maximum load Maximum spin speed	Programme description (Type of load and soil level)
<b>Washing/Drying programmes<sup>1)</sup></b>		
Cottons 95°C - Cold	9 kg 1600 rpm	<b>White cotton and coloured cotton.</b> Normal soil and light soil.
Cottons Eco <sup>2)</sup> 60°C - 40°C	9 kg 1600 rpm	<b>White cotton and colour-fast cotton.</b> Normal soil. The energy consumption decreases and the time of the washing programme is extended.
Synthetics 60°C - Cold	4 kg 1200 rpm	<b>Synthetic items or mixed fabric items.</b> Normal soil.
 Wool/Silk 40°C - Cold	1.5 kg 1200 rpm	<b>Machine washable wool, hand washable wool and delicate fabrics</b> with «hand washing» care symbol. <sup>3)</sup>
Anti-Allergy 60°C	9 kg 1600 rpm	<b>White cotton items.</b> This programme removes micro-organisms thanks to the washing by 60°C and adds one rinse. In this way the wash is more effective.
<b>Drying programmes</b>		
Cotton dry	6 kg	Drying programme for <b>cotton items</b> .
Synthetic dry	4 kg	Drying programme for <b>synthetic items</b> .
 Wool dry	1 kg	Drying programme for <b>woollen</b> .
<b>Washing programmes</b>		
Delicates 40°C - Cold	4 kg 1200 rpm	<b>Delicate fabrics as acrylics, viscose, polyester items.</b> Normal soil.
Easy Iron 60°C - Cold	4 kg 800 rpm	<b>Synthetic items to be gentle washed.</b> Normal and light soil. <sup>4)</sup>

<b>Programme Temperature range</b>	<b>Maximum load Maximum spin speed</b>	<b>Programme description (Type of load and soil level)</b>
Super Eco Cold	3 kg 1200 rpm	<b>Mixed fabric</b> (cotton and synthetic items). <sup>5)</sup>
20 Min. - 3 Kg 40°C - 30°C	3 kg 1200 rpm	<b>Cottons and synthetics items with light soil level</b> or worn only once.
Rinse 0°C	9 kg 1600 rpm	To rinse and spin the laundry. <b>All fabrics.</b>
Spin/Drain <sup>6)</sup> 0°C	9 kg 1600 rpm	To spin the laundry and to drain the water in the drum. <b>All fabrics.</b>
<b>Steam programmes<sup>7)</sup></b>		
<p>Steam can be used for dried, washed or worn once laundry. These programmes can reduce creases and odours and make your laundry more soft.</p> <p>Do not use any detergent. If necessary, remove stains by washing or using localized stain removal.</p> <p>Steam programmes do not perform any hygienic cycle.</p> <p>Do not set a Steam programme with these types of items:</p> <ul style="list-style-type: none"> <li>• items where it is not specified on the care label as being suitable for tumble drying.</li> <li>• all items with plastic, metal, wooden parts or alike.</li> </ul>		
 Anticrease 40°C	up to 1.5 kg	Steam programme for <b>cotton and synthetic items</b> . This cycle helps to dewrinkle the laundry.

Programme Temperature range	Maximum load Maximum spin speed	Programme description (Type of load and soil level)
 Refresh 40°C	up to 1.5 kg	Steam programme for <b>cotton and synthetic items</b> . This cycle removes odours from the laundry. <sup>8)</sup>

1) When you set a Washing / Drying programme, the display tells you that the drying cycle is not set. If you want to dry your laundry, set an automatic drying or a timed drying.

2) The washing programme Cottons Eco at 60°C with a load of 9 kg and the drying programme Cotton dry are the reference programmes for the data entered in the energy label, in compliance with EEC 92/75 standards.

3) During this cycle the drum rotates slowly to ensure a gentle washing. It can seem that the drum doesn't rotate or doesn't rotate properly. Consider this as a normal functioning of the appliance.

4) To reduce the creases of the laundry, this cycle regulates the water temperature and performs a soft wash and spin phase. The appliance adds some rinses. This programme is not compatible with drying.



5) This programme is for daily use and has lowest energy and water consumption maintaining a good washing performance.

6) Set the spin speed. Make sure it agrees with the laundry. If you set No Spin option the only drain phase is available.

7) If you set a Steam programme with dried laundry, at the end of the cycle the laundry could be humid. It is better to expose the items to the fresh air for about 10 minutes to let the humidity dry. When the programme is completed, quickly remove the laundry from the drum. After a steam cycle, items may to be ironed anyway, but with less effort!

8) Steam does not remove animal odours.

### Programme options compatibility

Programme	Spin	-- -- 	Pre-wash	Stains	Soak	Extra Rinse <sup>1)</sup>	Time Sav <sub>e</sub> <sup>2)</sup>	Delay Start
Cottons	■	■	■	■	■	■	■	■
Cottons Eco	■	■	■	■		■	■ <sup>3)</sup>	■
Synthetics	■	■	■	■	■	■	■	■
 Wool/Silk	■	■						■
Anti-Allergy	■	■	■	■		■		■
Delicates	■	■	■	■		■	■	■
Easy Iron	■	■	■	■	■	■	■	■
Super Eco	■	■				■		■
20 Min. - 3 Kg	■							■
Rinse	■	■				■		■

Programme	Spin	Pre-wash	Stains	Soak	Extra Rinse <sup>1)</sup>	Time Save <sup>e2)</sup>	Delay Start
Spin/Drain	■ ■ ■ ■	□					■

- 1) If the Permanent Extra Rinse option is activated, the appliance adds some additional rinses. In the Rinse programme, if you set a low spin speed the appliance performs delicate rinses and a short spin.
- 2) If you set a shorter duration, we recommend that you decrease the quantity of the load. It is possible to load fully the appliance, however the washing results are reduced.
- 3) For this programme you can set only the Extra Quick duration.

## 5.2 Programmes for automatic drying

Dryness Level	Type of fabric	Load
<b>Extra Dry</b> For towelling materials	<b>Cottons and Linen</b> (bathrobes, bath towels, etc)	up to 6 kg
<b>Cupboard Dry<sup>1)</sup></b> For items to put away	<b>Cottons and Linen</b> (bathrobes, bath towels, etc)	up to 6 kg
	<b>Synthetics and mixed fabrics</b> (jumpers, blouses, underwear, household linen)	up to 4 kg
<b>Iron Dry</b> Suitable for ironing	<b>Cottons and Linen</b> (sheets, tablecloths, shirts, etc)	up to 6 kg

1) **Hints for test institute** The test performance, in accordance with EN 50229:2007-07, must be carried out by setting the AUTOMATIC CUPBOARD DRY programme for Cotton with a load composition according to EN61121. Clean the air filters after each cycle.

## 5.3 Programmes for timed drying

Dryness Level	Type of fabric	Load (kg)	Spin speed (rpm)	Suggested duration (mins)
<b>Extra Dry</b> For towelling materials	<b>Cottons and Linen</b> (bathrobes, bath towels, etc)	6	1600	240 - 250
		3	1600	120 - 140
		1	1600	50 - 60
<b>Cupboard Dry</b> For items to put away	<b>Cottons and Linen</b> (bathrobes, bath towels, etc)	6	1600	230 - 240
		3	1600	110 - 130
		1	1600	40 - 50
<b>Cupboard Dry</b> For items to put away	<b>Synthetics and mixed fabrics</b> (jumpers, blouses, underwear, household linen)	4	1200	180 - 190
		2	1200	80 - 90

Dryness Level	Type of fabric	Load (kg)	Spin speed (rpm)	Suggested duration (mins)
<b>Iron Dry</b> Suitable for ironing	<b>Cottons and Linen</b> (sheets, tablecloths, shirts, etc)	6	1600	210 - 220
		3	1600	90 - 100
		1	1600	30 - 40
<b>Wool dry</b>	<b>Wool</b> (wool jumpers)	1	1200	80 - 100

## 5.4 Woolmark certificate



- The wool wash cycle of this machine has been approved by The Woolmark Company for the washing of wool garments labelled as «hand wash» provided that the garments are washed according to the instructions issued by the manufacturer of this

washing machine. Follow the garment care label for drying and other laundry instructions. 1230

- The wool drying cycle of this machine has been approved by The Woolmark Company for the drying of wool garments labelled as «hand wash» provided that the garments are dried according to the instructions issued by the manufacturer of this machine. Follow the garment care label for other laundry instructions. 1399

In UK, Eire, Hong Kong and India the Woolmark symbol is a certification trademark.

## 6. CONSUMPTION VALUES



The data of this table are approximate. Different causes can change the data: the quantity and type of laundry, the water and ambient temperature.



At programme start the display shows the duration programme for the maximum load capacity. During the washing phase the programme duration is automatically calculated and can be greatly reduced if the laundry load is lower than the maximum load capacity (e.g. Cotton 60°C, maximum load capacity 9 kg, the programme duration exceeds 2 hours; real load 1 kg, the programme duration don't reach 1 hour). When the appliance is calculating the real programme duration a dot blinks in the display.

Programmes	Load (kg)	Energy consumption (kWh)	Water consumption (litre)	Approximate programme duration (minutes)
Cottons 60 °C	9	1.68	71	180



Programmes	Load (kg)	Energy consumption (kWh)	Water consumption (litre)	Approximate programme duration (minutes)
Cotton Energy Saving Programme 60 °C <sup>1)</sup>	9	1.094	69	238
Cottons 40 °C	9	1.05	71	175
Synthetics 40 °C	4	0.88	60	142
Delicates 40 °C	4	0.70	63	91
Wool/Handwash 30 °C	1.5	0.35	59	58

1) «Cotton Energy Saving programme » at 60°C with a load of 9 kg is the reference programme for the data entered in the energy label, in compliance with EEC 92/75 standards.

## 7. SETTINGS

### 7.1 Acoustic signals

You can hear the acoustic signals when:

- You activate the appliance.
- You deactivate the appliance.
- You touch the buttons.
- The programme is completed.
- The appliance has a malfunction.

To **deactivate/activate** the acoustic signals, press Stains/Prewash and Extra Rinse at the same time for 6 seconds.



If you deactivate the acoustic signals, they continue operate only when you touch the buttons and when a malfunction occurs.

### 7.2 Child Lock function

With this function you can prevent that the children play with the control panel.

- To **activate/deactivate** this function, touch Temp.°C and Spin buttons at

the same time until the indicator comes on/goes off.

You can activate this function:

- After you touch Start/Pause : all the buttons and the programme knob are deactivated.
- Before you touch Start/Pause : the appliance cannot start.

### 7.3 Permanent Extra Rinse

With this function you can keep the extra rinse permanently on when you set a new programme.

- To **activate/deactivate** this function touch Time Save and Delay Start at the same time until the display show the indicator + comes on/goes off.

## 8. OPTIONS

### 8.1 Touch Screen



Make sure the touch screen and buttons are always clean and dry.

### 8.2 On/Off

Press this button to activate or deactivate the appliance. A tune sounds when the appliance is activated.

The AUTO Stand-by function automatically deactivates the appliance

to decrease the energy consumption when:

- You do not use the appliance for 5 minutes before you press Start/Pause button.  
All settings are cancelled.  
Press the button On/Off to activate the appliance again.  
Set again the washing programme and all possible functions.
- After 5 minutes from the end of the washing programme  
Refer to 'At the end of the programme'

### 8.3 Programme knob

Turn this knob to set a programme. The related programme indicator comes on.

### 8.4 Auto Dry

Touch this button to set one of 3 automatic dryness levels proposed by the appliance. On the control panel the dryness indicators illuminate accordingly.

The text bar in the display shows the set dryness level:

- **Iron dry** – 1 indicator on: laundry to be ironed
- **Cupboard dry** – 2 indicators on: laundry to be put in store
- **Extra dry** – 3 indicators on: laundry to be fully dried



You can not set all automatic levels for each type of fabrics.

### 8.5 Time Dry

Touch this button to set the time that suits the fabrics you have to dry. The text bar in the display shows the set value.

Each time you touch this button the time value increases by 5 minutes.



You cannot set all time values for different types of fabrics.

### 8.6 Steam

Touch this button to set the steam level. This is possible only with programmes

where the steam function is available. The duration of the steam phase changes accordingly to your selection.

### 8.7 Start/Pause

Touch button Start/Pause to start or interrupt a programme.

### 8.8 Delay Start

Touch button Delay Start to delay the start of a programme from 30 minutes to 20 hours.

### 8.9 Time Save

Touch button Time Save to decrease the programme time.

You can select:

- **SHORTENED DURATION:** to wash items with daily soil.
- **EXTRA QUICK:** to wash quickly items with almost no soil.



Some programmes accept only one of these functions.





### 8.10 Extra Rinse

Touch this button to add rinsing phases to a programme.

Use this function for persons allergic to detergents and in areas where the water is soft.

### 8.11 Stains/Prewash

Touch this button to set one of the following functions:

-  **Prewash**  
Use this function for heavy soil. The appliance adds a prewash phase to the main wash. The programme duration increases.
-  **Soak**  
Use this function for heavy soil. The appliance soaks the laundry at 30°C for about half an hour before to wash.
-  **Stains**  
Use this function for laundry with hard stains to remove. When you set this function, put the stain remover into compartment .

- i** The programme duration increases. This function is not available with a temperature lower than 40° C.

## 8.12 Spin

Touch button Spin to:

- Decrease the maximum speed of the spin phase of the programme.

- i** The display shows only the spin speeds available for the set programme.

- Deactivate the spin phase ('No spin' function).
- Activate the **Rinse Hold** function. Set this function to prevent fabric creases. The appliance does not drain the water when the programme is completed.

## 8.13 Temp.°C

Touch this button to change the default temperature.

Symbols **--** and **\*** = cold water

# 9. BEFORE FIRST USE

1. Put a small quantity of detergent in the compartment for washing phase.
2. Set and start a programme for cotton at the highest temperature without laundry.

This removes all possible dirt from the drum and the tub.

## 9.1 Clock setting

After you set the language, the display tells to set the clock. The hour digits flash.

1. Turn the programme knob to change the hour.
2. Touch Start/Pause button to confirm the selection.

The minute digits flash.

3. Turn the programme knob to change the minutes.
4. Touch Start/Pause button to confirm the selection.

## 9.2 Change the time of the day after the first activation

1. Touch the button Extra Rinse and the button Time Save at the same time for some seconds.

The hour digits flash.

2. Turn the programme knob to change the hour.
3. Touch Start/Pause button to confirm the selection.

The minute digits flash.

4. Turn the programme knob to change the minutes.
5. Touch Start/Pause button to confirm the selection.

## 9.3 Language setting

The first time you activate the appliance, the display shows the default language and tells you to confirm it or change it:

1. Turn the programme knob to set the desired language.
2. When the display shows the necessary language touch Start/Pause button to confirm the selection.

## 9.4 Change the language after the first activation

1. Touch button Spin and button Stains/Prewash at the same time for some seconds.
2. When the display shows the language set, turn the programme knob to set the new language.
3. Touch Start/Pause button to confirm the selection.

## 10. DAILY USE - WASHING ONLY

### 10.1 Before activating the appliance

1. Open the water tap.
2. Connect the mains plug to the mains socket.

### 10.2 Activating the appliance and setting a programme

1. Press button On/Off to activate the appliance.
2. Turn the programme knob to the necessary programme or touch one of the Memory buttons to set a memorised programme.

The programme indicator comes on.

The indicator of Start/Pause button flashes with red colour.

The display shows the default temperature and spin and the empty indicator bars of the available functions.

3. If it is necessary, touch Temp.°C button and Spin button to change the water temperature and the spin speed.
4. If necessary, touch the other buttons to add some functions or to set a delayed start.

The display shows the symbol of the set function and the digit shows the delayed time.

### 10.3 Loading the laundry

1. Open the appliance door
2. Put the laundry in the drum, one item at a time.
3. Shake the items before you put them in the appliance.

Make sure not to put too much laundry in the drum.

4. Close the door.

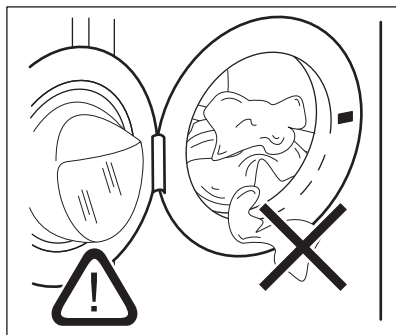

#### CAUTION!

Make sure that no laundry stays between the seal and the door. There is a risk of water leakage or damage to the laundry.

### 10.4 Filling the detergent and additives

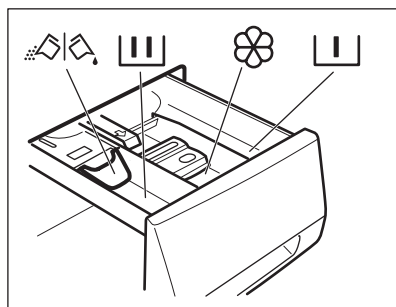

Compartment for prewash phase, soak programme or stain remover.



Compartment for washing phase.



Compartment for liquid additives (fabric conditioner, starch).

**MAX**

Maximum level for quantity of liquid additives.



Flap for powder or liquid detergent.



Always obey the instructions that you find on the packaging of the detergent products.

## 10.5 Liquid or powder detergent

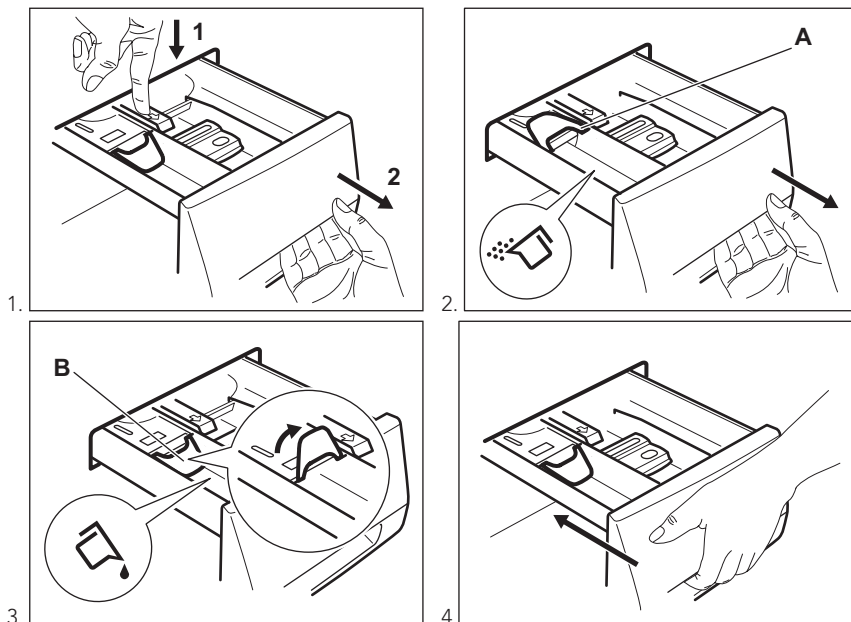

- Position **A** for powder detergent (factory setting).
- Position **B** for liquid detergent.



### When you use the liquid detergent:

- Do not use gelatinous or thick liquid detergents.
- Do not put more liquid than the maximum level.
- Do not set the prewash phase.
- Do not set the delay start.

## 10.6 Starting a programme without the delay start

Touch button Start/Pause to start the programme.

The relevant indicator stops to flash and stays on with red colour.

The programme starts, the door is locked. The display show the indicator



The drain pump can operate for a short time when the appliance fills water.

## 10.7 Behaviour of the appliance



After approximately 15 minutes from the start of the programme:

- The appliance adjusts automatically the cycle time to the laundry you have put in the drum to have perfect washing results in the minimum necessary time.
- The display shows the new time value.

## 10.8 Starting a programme with the delay start

1. Touch button Delay Start again and again to set the desired delayed start.

The display show the expected end of the programme.

2. Touch button Start/Pause.

The appliance starts the countdown of the delay start.

When the countdown is completed, the programme starts automatically.



Before you touch button Start/Pause to start the appliance, you can cancel or change the set of the delay start.

## 10.9 Cancelling the delay start

1. Touch button Start/Pause. The related indicator flashes.
2. Touch button Delay Start again and again until the display tells that there is no delay start.
3. Touch button Start/Pause. The programme starts.

## 10.10 Interrupting a programme and changing the options

You can change only some options before they operate:

1. Touch button Start/Pause. The related indicator flashes.
2. Change the options.
3. Touch button Start/Pause again. The washing programme continues.

## 10.11 Cancelling a programme

1. Press button On/Off to cancel the programme and to deactivate the appliance.
2. Press button On/Off again to activate the appliance.

Now, you can set a new washing programme.



Before starting the new programme the appliance drains the water. Make sure that the detergent is still in the detergent compartment, if not fill the detergent again.

## 10.12 Opening the door



### WARNING!

If the temperature and level of the water in the drum are too high and the drum still rotates you **cannot** open the door.

While a programme or the delay start operates, the appliance door is locked.

### To open the appliance door:

1. Touch button Start/Pause. The door lock symbol in the display goes off.
2. Open the appliance door.
3. Close the appliance door and touch button Start/Pause. The programme or the delay start continues

## 10.13 End of the programme

When the programme has finished, the appliance stops automatically. The acoustic signal operates (if it is active).

In the display  comes on and a message tells you that the programme is completed.

The indicator of Start/Pause button goes off.

1. Press the button On/Off to deactivate the appliance.

After five minutes from the end of the programme, the energy saving function automatically deactivates the appliance.



When you activate the appliance again, the display show the end of the last set programme. Turn the programme knob to set a new cycle.

2. Remove the laundry from the appliance.
3. Make sure that the drum is empty.
4. Keep the door and air filter ajar, to prevent mildew and odours.
5. Close the water tap.

## 10.14 Draining water out after end of cycle

**The washing programme is completed, but there is water in the drum:**

- The drum turns regularly to prevent the creases in the laundry.
- The door stays locked.
- You must drain the water to open the door:
  1. If necessary, decrease the spin speed.
  2. Touch the Start/Pause button. The appliance drains the water and spins.
  3. When the programme is completed and the door lock indicator goes off, you can open the door.
  4. Press On/Off some seconds to deactivate the appliance.

# 11. DAILY USE - DRYING



**WARNING!**  
Refer to Safety chapters.

## 11.1 Preparation to drying



**WARNING!**  
**Open the water tap. Put the drain hose in the sink or connect to the drain pipe.**

1. Press button On/Off for some seconds to activate the appliance
2. Load the laundry one item at a time.
3. Turn the programme dial to the drying programme applicable for the items to dry.



The appliance drains and spins automatically after approximately 18 hours.

## 10.15 AUTO Stand-by option

The AUTO Stand-by option automatically deactivates the appliance to decrease the energy consumption when:

- You do not use the appliance for 5 minutes before you press Start/Pause button.  
Press the button On/Off to activate the appliance again.
- After 5 minutes from the end of the washing programme  
Press the button On/Off to activate the appliance again.  
The display shows the end of the last set programme.  
Turn the programme knob to set a new cycle.

The text bar in the display tells which programme you have chosen.



When drying a big amount of laundry, to have good drying performances, make sure that the laundry itself is not rolled up and that is uniformly distributed in the drum.



At the beginning of the drying cycle (3 – 5 min.) there could be a slightly higher sound level. This is the compressor start and it is quite normal for compressor powered appliances such as refrigerators, freezers and so on.

## 11.2 Automatic drying

1. Touch button Auto Dry repeatedly to set the required dryness level. The indicators on the control panel illuminate accordingly:
  - a. **IRON DRY** level - 1 indicator on: for cotton items
  - b. **CUPBOARD DRY** level - 2 indicators on: for cotton and synthetic items
  - c. **EXTRA DRY** level - 3 indicators on : indicator for cotton items





You cannot set all dryness levels for any type of laundry.

The display shows the time end and the set drying programme.

2. Touch button Start/Pause to start the programme.

The text bar tells that the appliance is drying.

The display shows the door locked  indicator and the programme in progress  indicator and, alternatively, the time of the cycle end.

The display updates regularly the drying cycle time (every minute).



## 11.3 Timed drying

1. Touch button Time Dry again and again to set the time value (see the «Drying Programme» table).

The display shows 15 minutes for cottons and synthetics programmes while starts from 13 minutes for wool programme.

Each time you press this button the time value increases by 5 minutes. The display shows the set time value.

2. Press Start/Pause to start the programme. The text bar tells that the appliance is drying.

On the display appear the door locked  and the programme in progress  indicators.



The display shows alternatively, the drying cycle duration and the time of the cycle end.

The display updates regularly the drying cycle value.



If the laundry is not sufficient dry, set again a short drying time.

## 11.4 At the end of the drying programme

- The appliance stops automatically.
- The acoustic signals operate (if they are active).
- In the display  comes on. The text bar tells you that the programme is completed.
- The indicator of button Start/Pause goes off. The door locked  goes off
- Press the button On/Off for some seconds to deactivate the appliance.



After some minutes from the end of the programme, the energy saving function automatically deactivates the appliance.

1. Remove the laundry from the appliance. Make sure that the drum is empty.
2. Close the water tap.

# 12. DAILY USE - WASHING & DRYING



**WARNING!**  
Refer to Safety chapters.



## 12.1 NON-STOP programme

You can wash and dry your laundry setting a «non stop-programme». Proceed as follows:

1. Press button On/Off for some seconds to activate the appliance .
2. Load the laundry one item at a time.
3. Put the detergent and the additives in the appropriate compartment.
4. Turn the programme dial to the washing programme. The display shows the default temperature and spin. If necessary, change them according to your laundry.
5. Set the available options.

## 12.2 Washing and Drying at automatic levels

1. Touch button Auto Dry repeatedly until the display shows the required dryness level. The indicators above the button illuminate accordingly:
  - a. **IRON DRY** level: 1 indicator on - for cotton items;
  - b. **CUPBOARD DRY** level: 2 indicators on - for cotton and synthetic items;
  - c. **EXTRA DRY** level: 3 indicators on - for cotton items.



The display shows that the appliance is ready to start.

**The time value on the display is the duration of both cycles washing and drying, calculated on a default load size.**



To have a good drying the appliance does not let you set a too low spin speed for the items to be washed and dried.

2. Touch button Start/Pause to start the programme.

The display shows the door locked  indicator and the programme in progress  indicator and, alternatively, the drying time and the time of the cycle end.

The text bar tells that the appliance is operating.  
The display shows regularly a new time value.

## 12.3 At the end of the programme

The appliance stops automatically. The acoustic signals operate (if they are active).

For more information see 'At the end of the drying programme ' of the previous chapter.

## 12.4 Fluff in the fabrics

During the washing and/or drying phase, some types of fabric, (sponge, wool, sweatshirt) could release fluff.

The released fluff could stick to the fabrics during the next cycle.

This inconvenient increases with technical fabrics.

To prevent the fluff in your laundry, we recommend that you:

- To do not wash dark fabrics after you washed and dried light coloured fabrics (new sponge, wool, sweatshirt ) and the contrary.
- To dry this type of fabrics at open air when they are washed the first time.
- To clean the drain filter.
- After the drying phase, clean the empty drum, the gasket and the door with a wet cloth.

**To remove the fluff inside the drum, set a special programme:**

- Empty the drum.
- Clean the drum, the gasket and the door with a wet cloth.
- Set the rinse programme.
- Press at the same time Spin and Extra Rinse to activate the cleaning function until the display shows **CLE**.
- Press Start/Pause to start the programme.

## 13. HINTS AND TIPS



### WARNING!

Refer to Safety chapters.

### 13.1 The laundry load

- Divide the laundry in: white, coloured, synthetics, delicates and wool.
- Obey the washing instructions that are on the laundry care labels.
- Do not wash together white and coloured items.
- Some coloured items can discolour with the first wash. We recommend that you wash them separately for the first times.
- Button up pillowcases, close zippers, hooks and poppers. Tie up belts.
- Empty the pockets and unfold the items.
- Turn inside out multilayered fabrics, wool and items with painted illustrations.
- Remove hard stains.
- Wash with a special detergent heavy soil stains.
- Be careful with the curtains. Remove the hooks or put the curtains in a washing bag or pillowcase.
- Do not wash in the appliance laundry without hems or with cuts. Use a washing bag to wash small and/or delicate items (e.g. underwired bras, belts, tights, etc. ).
- A very small load can cause balance problems with the spin phase. If this occurs, adjust manually the items in the tub and start the spin phase again.

### 13.2 Stubborn stains

For some stains, water and detergent is not sufficient.

We recommend that you remove these stains before you put the items in the appliance.

Special stain removers are available. Use the special stain remover that is applicable to the type of stain and fabric.

### 13.3 Detergents and additives

- Only use detergents and additives specially made for washing machines:
  - powder detergents for all types of fabric,
  - powder detergents for delicate fabrics (40 °C max) and woollens,
  - liquid detergents, preferably for low temperature wash programmes (60 °C max) for all types of fabric, or special for woollens only.
- Do not mix different types of detergents.
- To help the environment, do not use more than the correct quantity of detergent.
- Obey the instructions that you find on the on packaging of these products.
- Use the correct products for the type and colour of the fabric, the programme temperature and the level of soil.
- If your appliance has not the detergent dispenser with the flap device, add the liquid detergents with a dosing ball (supplied by the detergent's manufacturer).

### 13.4 Ecological hints

- Set a programme without the prewash phase to wash laundry with normal soil.
- Always start a washing programme with the maximum load of laundry.
- If necessary, use a stain remover when you set a programme with a low temperature.
- To use the correct quantity of the detergent, check the water hardness of your domestic system

### 13.5 Water hardness

If the water hardness in your area is high or moderate, we recommend that you use a water softener for washing machines. In areas where the water hardness is soft it is not necessary to use a water softener.

To know the water hardness in your area, contact your local water authority.

Use the correct quantity of the water softener. Obey the instructions that you find on the packaging of the product.

## 13.6 Drying hints

### Prepare the drying cycle

- Open the water tap.
- Do a check if the connection of the drain hose is correct. Refer to installation chapter for more information.
- For the maximum laundry load of the drying programmes, refer to the drying programmes table.



## 13.7 Items to do not dry

### Do not set a drying programme for this laundry:

- Very delicate items.
- Synthetic curtains.
- Pieces of clothing with metal inserts.
- Nylon stockings.
- Quilts.
- Bed covers.
- Duvets.
- Anoraks.
- Sleeping bags
- Fabrics with residue of hair sprays, nail solvents or similar.
- Garments with foam-rubber or materials similar to foam-rubber.

## 13.8 Garment labels

When you dry the laundry, obey the indications on the labels of the manufacturers:

-  = The item can be tumble dried
-  = The drying cycle is at high temperature
-  = The drying cycle is at reduced temperature

-  = The item can not be tumble dried.

## 13.9 Drying cycle duration

The drying time can change depending on:

- speed of the last spin
- dryness level
- type of laundry
- weight of the load size

## 13.10 Additional drying

If, at the end of the drying programme, the laundry is still damp, set a short drying cycle again.



### WARNING!

**To avoid creases of fabrics or shrinks of the clothing do not over dry the laundry.**

## 13.11 General Tips

Refer to the «Drying programmes» table to find the **average** drying times. The experience will help you to dry the laundry in a more correct way. Take note of the duration drying time of the cycles done before.

To avoid the static charge at the end of the drying cycle:

1. Use fabric conditioner in the washing cycle.
2. Use special fabric conditioner for tumble dryers.

When the drying programme is completed remove the laundry in a short time.

# 14. CARE AND CLEANING



### WARNING!

Refer to Safety chapters.



### CAUTION!

Do not use alcohol, solvents or chemical products.

## 14.1 External cleaning

Clean the appliance only with soap and warm water. Fully dry all the surfaces.

## 14.2 Descaling

If the water hardness in your area is high or moderate, we recommend that you use a water descaling product for washing machines.

Regularly examine the drum to prevent limescale and rust particles.

To remove rust particles use only special products for washing machine. Do this separately from the laundry wash.



Always obey the instructions that you find on the packaging of the product.

## 14.3 Maintenance wash

With the low temperature programmes it is possible that some detergent stays in

## 14.5 Cleaning the detergent dispenser

1.

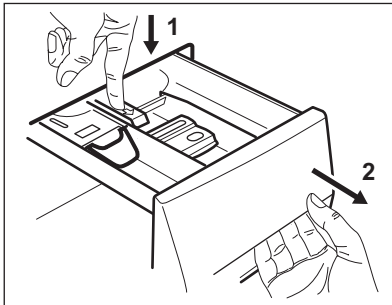

3.

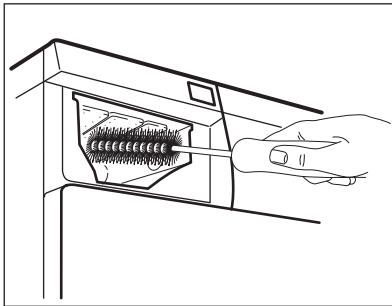

the drum. Make regularly a maintenance wash. To do this:

- Remove the laundry from the drum.
- Set the cotton programme with the highest temperature with a small quantity of detergent.

## 14.4 Door seal

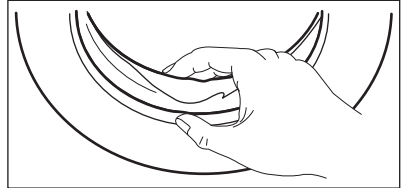

Regularly examine the seal and remove all objects from the inner part.

2.

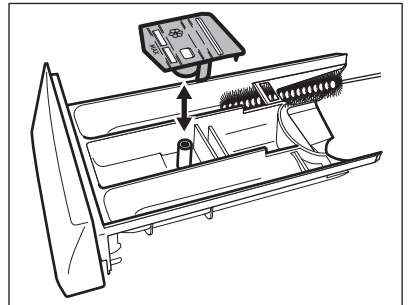

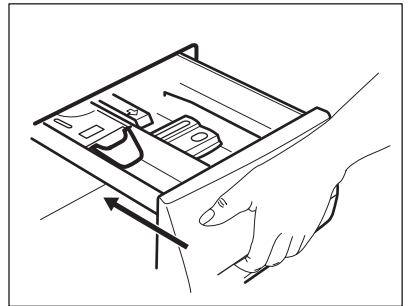

4.



## 14.6 Cleaning the air filters

**i** The air filters collect the fluff. The fluff normally occurs when the clothes are dried in a washer-dryer.

- At the end of each drying cycle in the display the indicator  is on to tell you to clean the primary air filter.  
The text bar says to clean the primary filter (see pict. 1-5).
- Occasionally the indicator  may flash to remind you that both air filters should be cleaned.  
The acoustic signal operate and the text bar says to check the primary and secondary filters (see pict. 6-8).

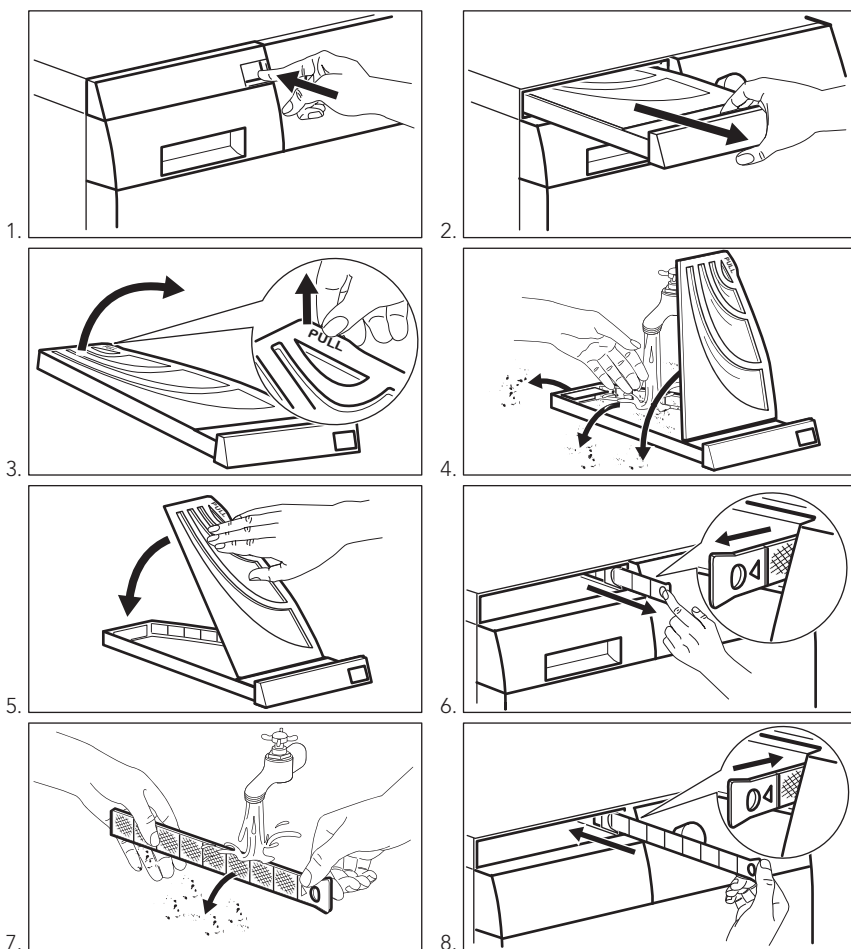

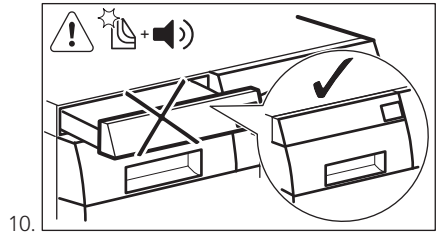
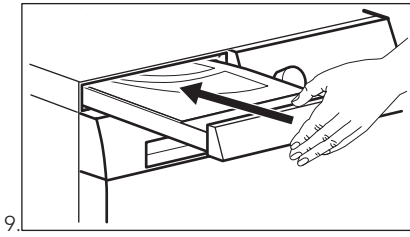

Cleaning regularly the air filters **with warm water** allows you to have best drying performances. Clogged filter increases the drying time.



**WARNING!**

The primary filter recess must not be blocked by any object.



If you only wash the laundry with your washer-dryer, it is normal to find some humidity in the primary air filter.

## 14.7 Cleaning the drain filter



**WARNING!**

Do not clean the drain filter if the water in the appliance is hot.

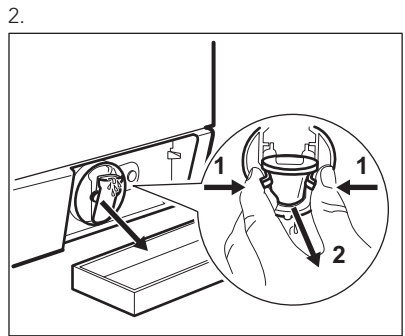
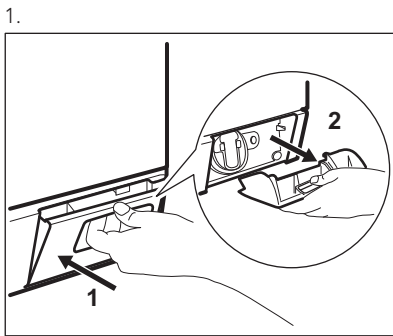

3.

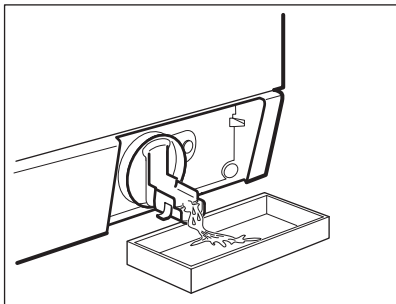

4.

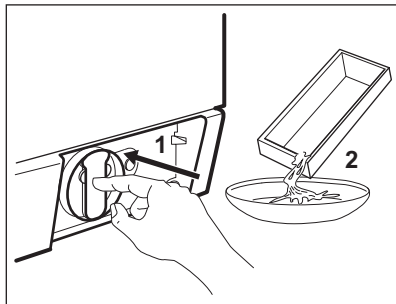

5.

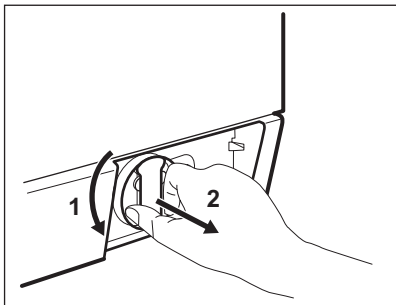

6.

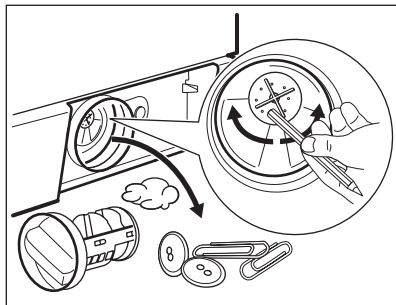

7.

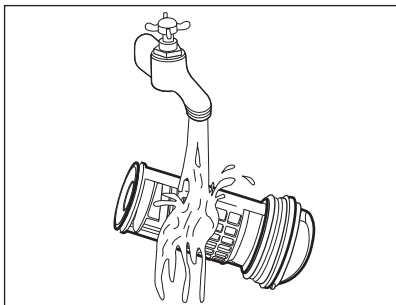

8.

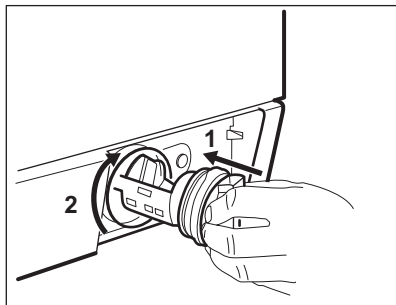

9.

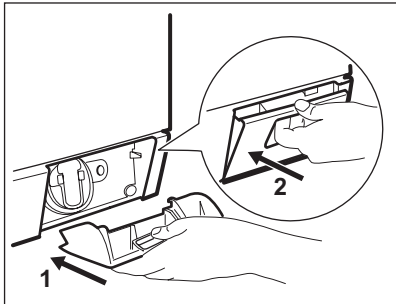

## 14.8 Cleaning the inlet hose filter and the valve filter

It could be necessary to clean the filters when:

- The appliance does not fill with water.
- The appliance fills with the water for a long time.
- The indicator of button Start/Pause flashes and the display shows the related alarm. Refer to 'Troubleshooting'.

**To clean the water inlet filters:**

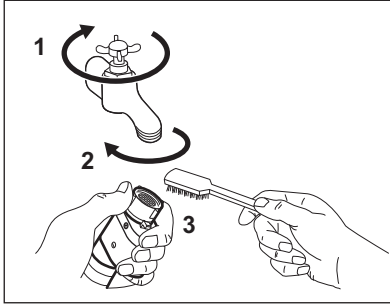

- Close the water tap.
- Remove the water inlet hose from the water tap.
- Clean the filter in the inlet hose with a stiff brush.

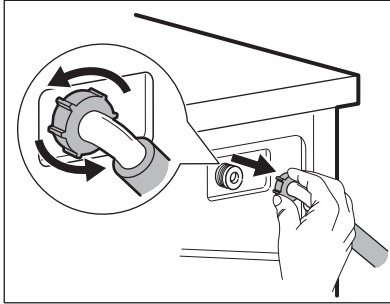

- Remove the inlet hose behind the appliance.

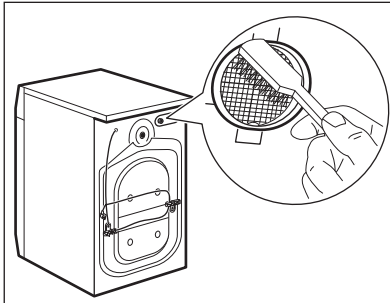

- Clean the filter in the valve with a stiff brush or a towel.

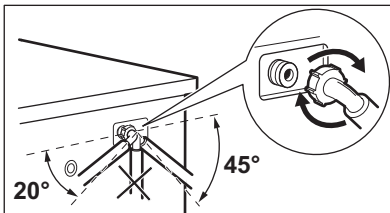

- Install again the inlet hose. Make sure that the couplings are tight to prevent leakages.
- Open the water tap.



## 14.9 Emergency drain

Because of a malfunction, the appliance cannot drain the water.

If this occurs, do steps (1) through (9) of 'Cleaning the drain filter'. If necessary, clean the pump.

When you drain the water with the emergency drain procedure, you must activate again the drain system:

1. When you drain the water with the emergency drain procedure, you must activate again the drain system: Put 2 litres of water in the main wash compartment of the detergent dispenser.
2. Start the programme to drain the water

## 14.10 Frost precautions

If the appliance is installed in an area where the temperature can be less than

0° C, remove the remaining water from the inlet hose and the drain pump.

1. Disconnect the mains plug from the mains socket.
2. Close the water tap.
3. Put the two ends of the inlet hose in a container and let the water flow out of the hose.
4. Empty the drain pump. Refer to the emergency drain procedure.
5. When the drain pump is empty, install the inlet hose again.



### WARNING!

Make sure that the temperature is more than 0 °C before you use the appliance again. The manufacturer is not responsible for damages caused by low temperatures.

# 15. TROUBLESHOOTING



### WARNING!

Refer to Safety chapters.

## 15.1 Introduction

The start of the appliance does not occur or it stops during operation. First try to find a solution to the problem (refer to the table). If not, contact the Authorised Service Centre.

**With some problems, the acoustic signals operate and the display shows an alarm message:**



### CAUTION!

Deactivate the appliance before you do the checks.

## 15.2 Possible failures

Problems with alarm messages

Message	Possible solution
<b>The display tells to check the tap: the appliance does not fill with water.</b>	Make sure that the water tap is open.
	Make sure that the pressure of the water supply is not too low. For this information, contact your local water authority.

Message	Possible solution
	Make sure that the water tap is not clogged or is furred with lime-scale.
	Make sure that the filter of the inlet hose and the filter of the valve are not clogged. Refer to "Care and cleaning".
	Make sure that the inlet hose is not damaged.
	Make sure that the connection of the water inlet hose is correct.
<b>The display tells to check the drain filter: the appliance does not drain the water.</b>	Make sure that the drain hose is not damaged.
	Make sure that the drain filter is not clogged. Clean the filter, if necessary. Refer to 'Care and cleaning'.
	Make sure that the connection of the drain hose is correct.
<b>The display tells to check the door.</b>	Make sure that the appliance door is not open or closed correctly.
<b>The display tells there is a water alert.</b>	The anti-flood device is activated: <ul style="list-style-type: none"> <li>• Disconnect the appliance.</li> <li>• Close the water tap.</li> <li>• Contact the service centre.</li> </ul>
<b>The display tells that the main supply is unstable.</b>	Wait until the mains supply is stable. The appliance automatically starts operating.
<b>The display tells to check the air filter (the indicator  flashes and the acoustic signal operates)</b>	Make sure that the filter drawer is correctly inserted.

#### Problems without alarm messages

Problem	Possible solution
<b>The programme does not start.</b>	Make sure that the mains plug is connected to the mains socket.
	Make sure that there is not a damaged fuse in the fuse box.
	Make sure that the you have touched Start/Pause.
	If the delay start is set, cancel the setting or wait for the end of countdown.
	Deactivate the Child Lock function if it is on.

<b>Problem</b>	<b>Possible solution</b>
<b>The appliance does not drain the water.</b>	Make sure that you have not set a programme without drain phase.
	Make sure that you have not set an option which ends with water in the tub.
<b>The appliance fills with water and drains immediately.</b>	Make sure that the drain hose is in the correct position. The hose may be too low.
<b>The spin phase does not operate or the washing cycle lasts longer than usually.</b>	Make sure that the spin phase is not off.
	Make sure that the drain filter is not clogged. Clean the filter, if necessary. Refer to 'Care and cleaning'.
	Make sure that this is not a balance problem. Adjust manually the items in the drum and start the spin phase again.
<b>There is water on the floor.</b>	Make sure that the couplings of the water hoses are tight and there is not water leakages.
	Make sure that the drain hose have no damages.
	Make sure you use the correct detergent and the correct quantity of it.
<b>You cannot open the appliance door.</b>	Make sure that the washing programme is finished.
	Set the drain or the spin programme if there is water in the drum.
	Make sure that the appliance receives electrical power.
	This problem may be caused by a failure of the appliance. Contact the Authorised Service Centre. If you need to open the door, please read carefully «Emergency door opening».
<b>The appliance makes an unusual noise.</b>	Make sure the levelling of the appliance is correct. Refer to 'Installation'.
	Make sure that the packaging and/or the transit bolts are removed. Refer to 'Installation'.
	Add more laundry in the drum. The load may be too small.
<b>The washing results are not satisfactory.</b>	Increase the detergent quantity or use a different detergent.

Problem	Possible solution
	Use special products to remove the stubborn stains before you wash the laundry.
	Make sure that you set the correct temperature.
	Decrease the laundry load.
<b>The washing cycle is shorter than the time displayed.</b>	The appliance calculates a new time according to the laundry load.
<b>The washing cycle is longer than the time displayed.</b>	An unbalanced laundry load increases the duration time. This is a normal behaviour of the appliance.
<b>After a steam programme, garments are partially wet.</b>	Make sure that the appliance is accurately levelled. Adjust the appliance by raising or lowering the feet.
<b>After a steam programme, garments are not sufficiently smooth.</b>	Make sure that you set a correct STEAM programme (e.g. Synthetic instead of Cotton).
<b>The appliance does not dry or does not dry correctly.</b>	Make sure the water tap is not closed.
	Make sure the drain filter is not clogged.
	Make sure you have set the correct cycle. If necessary, set again a short drying time.
<b>The drying cycle is too long.</b>	Make sure that the room temperature is in the correct range.
<b>The laundry is full of different colours fluff.</b>	Set a drying cycle to remove some fluff. Clean the laundry with a fluff remover.
<b>There is a big quantity of fluff in the drum.</b>	In case of an excessive amount of fluff in the drum run the special programme to clean it (refer to "FLUFF IN THE FABRICS" for more details).

After the check, activate the appliance. The programme continues from the point of interruption.

If the problem occurs again, contact the Authorised Service Centre.

If the display shows other alarm codes. Deactivate and activate the appliance. If the problem continues, contact the Authorised Service Centre.

### 15.3 Emergency door opening

In case of power failure or appliance failure the appliance door remains locked. The washing programme continues, when the power is restored. If the door remains locked in case of failure, it is possible to open it using the emergency unlock feature.

Before opening the door:



#### **CAUTION!**

**Make sure that the water temperature and the laundry are not hot. Wait till they cool down, if necessary.**



**CAUTION!**  
Make sure that the drum is not rotating. Wait till the drum stops rotating, if necessary.



Make sure that the water level inside the drum is not too high. Proceed with an emergency drain, if necessary (refer to «Emergency drain» in «Care and cleaning» chapter).

To open the door, proceed as follows:

1. Press the button On/Off to switch the appliance off.
2. Disconnect the mains plug from the mains socket.
3. Open the filter flap.
4. Keep the emergency unlock trigger pulled downward and, at the same time, open the appliance door.

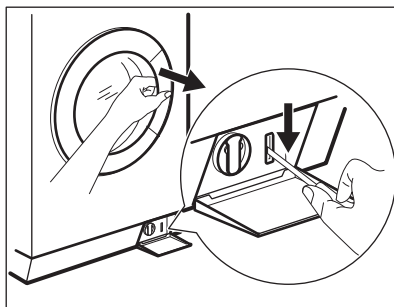

5. Take out the laundry and then close the appliance door.
6. Close the filter flap.

## 16. INSTALLATION



**WARNING!**  
Refer to Safety chapters.

### 16.1 Unpacking



**WARNING!**  
As you will put down the appliance on the rear side, **wait about 6 hours before you use it.** This time is necessary to enable the compressor to work properly.



**WARNING!**  
Remove all the packaging and the transit bolts before installing the appliance.

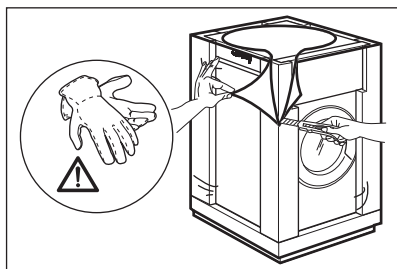

Use the gloves.

- Remove the external film. If necessary, use a cutter

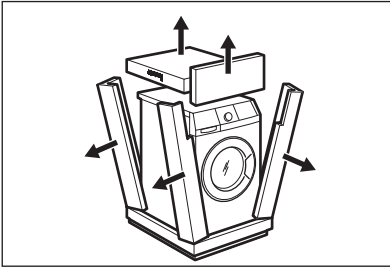

- Remove the cardboard top.
- Remove the polystyrene packaging materials.

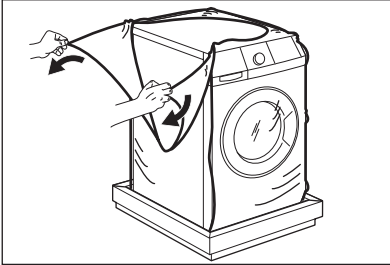

- Remove the internal film.



- Open the door.
- Remove the polystyrene piece from the door seal and all the items from the drum.

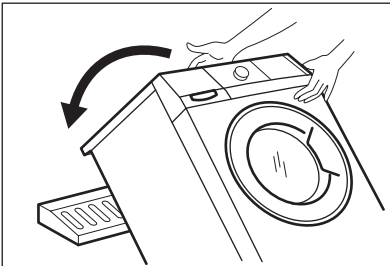

- Put one of the polystyrene packaging elements on the floor behind the appliance.
- Carefully put down the appliance with the rear side on it.
- Make sure not to damage the hoses.

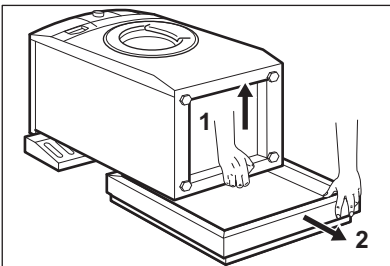

- Remove the polystyrene protection from the bottom.

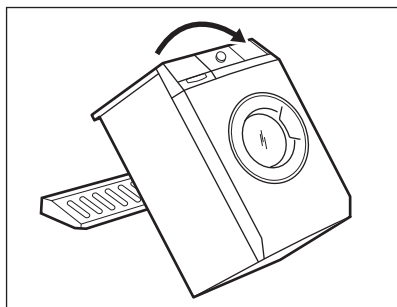

- Pull up the appliance in vertical position.

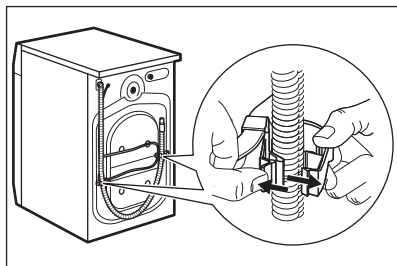

- Remove the power supply cable and the drain hose from the hose holders.

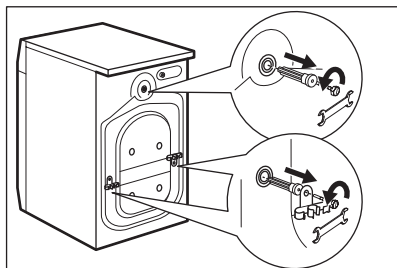

- Remove the three bolts.
- Use the key supplied with the appliance.
- Pull out the plastic spacers.

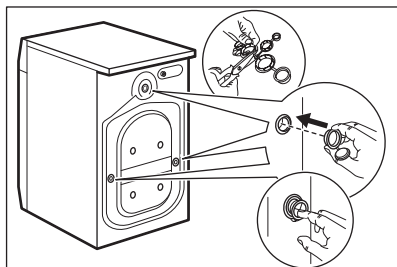

- Put the plastic caps in the holes.
- You can find these caps in the user manual bag.

**i** We recommend that you keep the packaging and the transit bolts for any movement of the appliance.

## 16.2 Fixing plate kit (4055171146)

Available from your authorized dealer.

If you install the appliance on a plinth, secure the appliance in the fixing plates.

Read carefully the instructions supplied with the kit.

## 16.3 Installation on suspended flooring

Suspended wooden floors are particularly susceptible to vibration.

To help prevent vibration we recommend you place a waterproof wood panel, at least 15 mm thick under

the appliance, secured to at least 2 floor beams with screws, the wood panel must extend beyond the front feet.

If possible install the appliance in one of the corners of the room, where the floor is more stable.

## 16.4 Installation under a counter

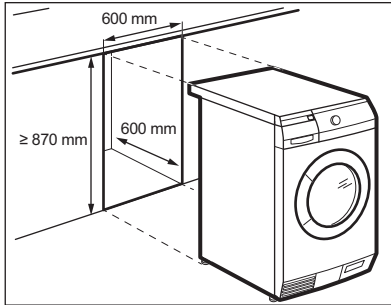

The appliance can be installed as freestanding or below the kitchen counter with correct space (see picture).



### CAUTION!

To assure free air circulation under the appliance, do not attach the sound barriers (if available).

## 16.5 Positioning and levelling

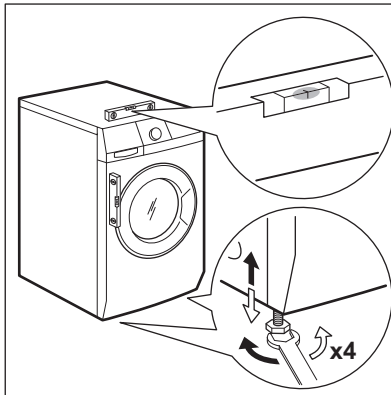

- Install the appliance on a flat hard floor.
- Make sure that carpets do not stop the air circulation below the appliance.
- Make sure that the appliance does not touch the wall or other units.
- Loosen or tighten the feet to adjust the level.

A correct adjustment of the appliance level prevents the vibration, noise and the movement of the appliance when in operation.

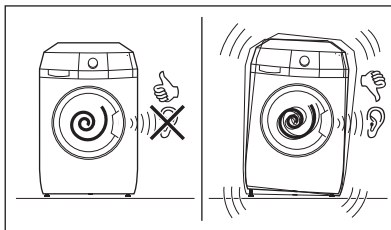

- The appliance must be level and stable.



### CAUTION!

Do not put cardboard, wood or equivalent materials below the appliance feet to adjust the level.



## 16.6 The inlet hose

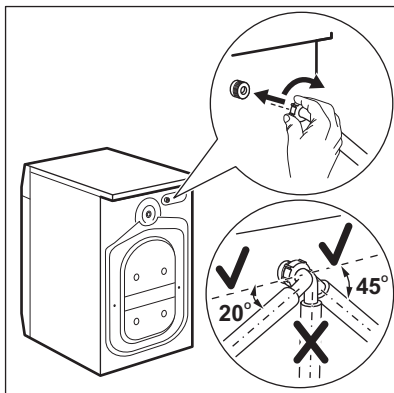

- Connect the hose to the back appliance. Turn the inlet hose only left or right.
- Loosen the ring nut to set it in the correct position.

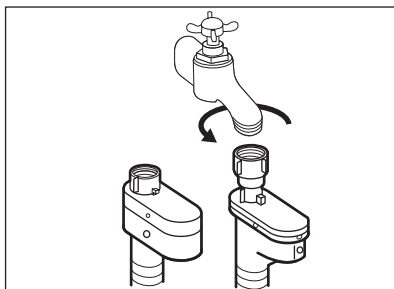

- Connect the water inlet hose to the cold water tap with 3/4 thread.



### CAUTION!

Make sure that there are no leaks from the couplings.



Do not use an extension hose if the inlet hose is too short. Contact the service centre for the replacement of the inlet hose.

## 16.7 Water-stop device

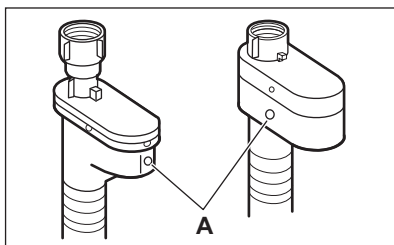

The inlet hose has a water stop device. This device prevents water leaks in the hose because of its natural ageing. The red sector in the window «A» shows this fault.

If this occurs, close the water tap and contact the service centre to replace the hose.

## 16.8 Water drainage

There are different procedures to connect the drain hose:

**With the plastic hose guide:**

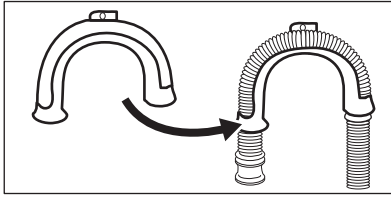

- Making an U form with the drain hose.

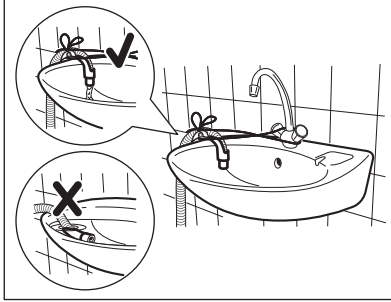

**On the edge of a sink**

- Make sure that the plastic guide cannot move when the appliance drains. Attach the guide to the water tap or the wall.

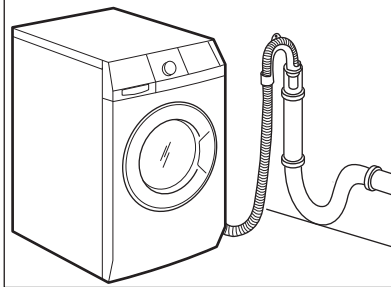

**To a stand pipe with vent-hole**

- Directly into a drain pipe at a height of not less than 60 cm (23.6") and not more than 100 cm (39.3"). Refer to the illustration.
- The end of the drain hose must always be ventilated, i.e. the inner diameter of the drain pipe (min. 38 mm - min. 1.5") must be larger than the external diameter of the drain hose.

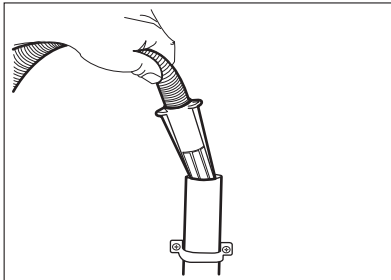

**Drain hose end**

- If the end of the drain hose looks like this (see the picture), you can push it directly into the stand pipe.

**Without the plastic hose guide.**

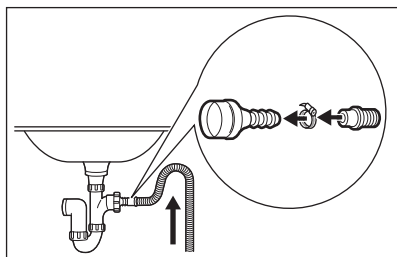
**To a sink spigot**

- Refer to the illustration. Put the drain hose in the spigot and tighten it with a clip.
- Make sure that the drain hose makes a loop to prevent that remaining particles go in the appliance from the sink.

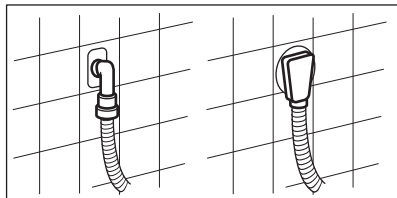
**To a wall-pipe**

- Directly to a built-in drain pipe in the room wall and tighten it with a clip.



You can extend the drain hose to maximum 400 cm. Contact the service centre for the other drain hose and the extension.

## 17. TECHNICAL DATA



Dimension	Width/ Height/ Depth/ Total depth	600 mm/ 870 mm/ 605 mm/ 640 mm
Electrical connection	Voltage	230-240 V
	Overall power	2200 W
	Fuse	13 A
	Frequency	50 Hz
Level of protection against ingress of solid particles and moisture ensured by the protective cover, except where the low voltage equipment has no protection against moisture		IPX4
Water supply <sup>1)</sup>		Cold water
Water supply pressure <sup>2)</sup>	Minimum	0,5 bar (0,05 MPa)
	Maximum	8 bar (0,8 MPa)
Ambient temperature	Minimum	5 °C
	Maximum	35 °C
Maximum wash load	Cotton	9
	Synthetics	4
	Wool	1.5
Maximum dry load	Cotton	6
	Synthetics	4

	Wool	1
Spin Speed	Maximum	1600 rpm

1) Connect the water inlet hose to a water tap with a 3/4" thread.

2) The appliance works correctly if the water pressure is not less than 0.05 MPa (0.5 bar). If you can not connect the water inlet hose to the cold water tap of the primary hydraulic system, connect it to your domestic cold water storage system. Make sure not to have more than a distance of 5.02 m (16.5 ft) between the appliance inlet hose and the bottom of the water storage tank.

## 18. ENVIRONMENTAL CONCERNS

Recycle the materials with the symbol . Put the packaging in applicable containers to recycle it. Help protect the environment and human health and to recycle waste of electrical and electronic appliances. Do not dispose appliances marked with the symbol  with the household waste. Return the product to your local recycling facility or contact your municipal office.







[www.aeg.com/shop](http://www.aeg.com/shop)



132908860-A-082014



 **AEG**  
perfekt in form und funktion