

Contents

1 Instructions	40
1.1 General safety instructions	40
1.2 Manufacturer liability	41
1.3 Appliance purpose	41
1.4 Disposal	41
1.5 Identification plate	42
1.6 This user manual	42
1.7 How to read the user manual	42
2 Description	43
2.1 General Description	43
2.2 Control panel	44
2.3 5 Other parts	44
2.4 Available accessories	45
3 Use	46
3.1 Instructions	46
3.2 First use	46
3.3 Using the accessories	47
3.4 Auxiliary oven	47
3.5 Main oven with display	48
3.6 Cooking advice	55
3.7 Special functions and automatic programs	56
3.8 Secondary menu	60
4 Cleaning and maintenance	64
4.1 Instructions	64
4.2 Cleaning the surfaces	64
4.3 Ordinary daily cleaning	64
4.4 Food stains or residues	64
4.5 Removing the door	64
4.6 Cleaning the door glazing	65
4.7 Removing the internal glass panels	65
4.8 Cleaning the inside of the oven	66
4.9 Vapor Clean: Assisted oven cleaning (main oven only)	68
4.10 Extraordinary maintenance	70
5 Installation	71
5.1 Electrical connection	71
5.2 Cable replacement	72
5.3 Positioning	72

We advise you to read this manual carefully, which contains all the instructions for maintaining the appliance's aesthetic and functional qualities.

For further information on the product: www.smeg.com



1 Instructions

1.1 General safety instructions

Risk of personal injury

- During use the appliance and its accessible parts become very hot.
- Never touch the heating elements during use.
- Keep children under eight years of age at a safe distance if they are not constantly supervised.
- Children must never play with the appliance.
- Never rest metallic objects such as knives, forks, spoons and lids on the appliance during use.
- Switch the appliance off immediately after use.
- Never try to put out a fire or flames with water: turn off the appliance and smother the flames with a fire blanket or other appropriate cover.
- The appliance must never be cleaned by unsupervised children.
- Have qualified personnel carry out installation and assistance interventions according to the standards in force.

- Do not modify this appliance.
- Do not insert pointed metal objects (cutlery or utensils) into the slots in the appliance.
- Do not try to repair the appliance yourself or without the intervention of a qualified technician.
- If the power supply cable is damaged, contact technical support immediately and they will replace it.

Risk of damaging the appliance

- Do not use abrasive or corrosive detergents on glass parts (e.g. powder products, stain removers and metallic sponges).
- Use wooden or plastic utensils.
- Do not seat on the appliance.
- Do not use steam jets for cleaning the appliance.
- Do not obstruct ventilation openings and heat dispersal slots.
- Never leave the appliance unattended during cooking operations where fats or oils could be released.
- Never leave objects on the cooking surface.
- Do not use the appliance to heat rooms for any reason.



For this appliance

- Ensure that the appliance is switched off before replacing the bulb.
- Do not rest any weight or sit on the open door of the appliance.
- Take care that no objects are stuck in the doors.

1.2 Manufacturer liability

The manufacturer declines all liability for damage to persons or property caused by:

- use of the appliance other than the one envisaged;
- non-observance of the user manual provisions;
- tampering with any part of the appliance;
- use of non-original spare parts.

1.3 Appliance purpose

- This appliance is intended for cooking food in the home environment. Every other use is considered improper.
- This appliance may be used by children aged at least 8 and by people of reduced physical and mental capacity, or lacking in experience in the use of electrical appliances, as long they are supervised or instructed by adults who are responsible for their safety.
- The appliance is not designed to operate with external timers or with remote-control systems.

1.4 Disposal



This appliance must be disposed of separately from other waste (Directives 2002/95/EC, 2002/96/EC, 2003/108/EC). The appliance does not contain substances in quantities sufficient to be considered hazardous to health and the environment, in accordance with current European directives.

To dispose of the appliance:

- Cut the power supply cable and remove it along with the plug.



Power voltage

Danger of electrocution

- Disconnect the main power supply.
- Disconnect the power cable from the electrical system.
- Consign the appliance to the appropriate selective collection centres for electrical and electronic equipment waste, or deliver it back to the retailer when purchasing an equivalent product, on a one for one basis.



Instructions

Our appliances are packed in non-polluting and recyclable materials.

- Consign the packing materials to the appropriate selective collection centres.



Plastic packaging Danger of suffocation

- Do not leave the packaging or any part of it unattended.
- Do not let children play with the packaging plastic bags.

1.5 Identification plate

The identification plate bears the technical data, serial number and brand name of the appliance. Do not remove the identification plate for any reason.

1.6 This user manual

This user manual is an integral part of the appliance and must therefore be kept in its entirety and in an accessible place for the whole working life of the appliance.

Read this user manual carefully before using the appliance.

1.7 How to read the user manual

This user manual uses the following reading conventions:

Instructions



General information on this user manual, on safety and final disposal.

Description



Description of the appliance and its accessories.

Use



Information on the use of the appliance and its accessories, cooking advice.

Cleaning and maintenance



Information for proper cleaning and maintenance of the appliance.

Installation



Information for the qualified technician: installation, operation and inspection.



Safety instructions



Information



Advice

1. Use instruction sequence.

- Single use instruction.



2 Description

2.1 General Description

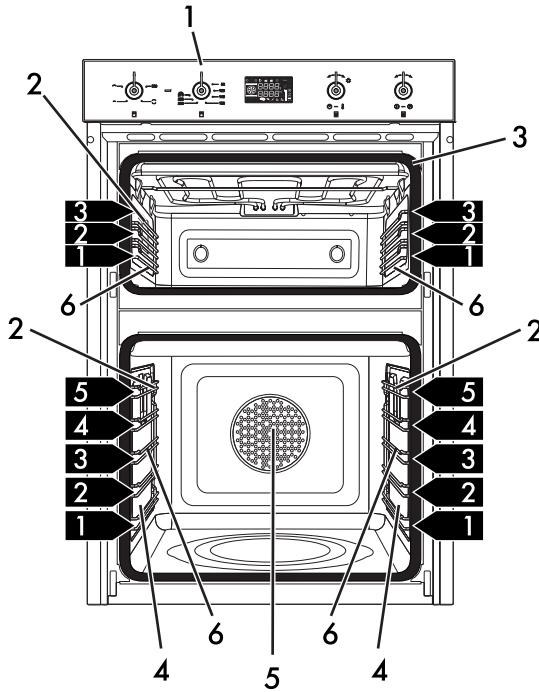

- 1 Control panel
- 2 Oven light
- 3 Oven seal
- 4 Self-cleaning panels

- 5 Main oven fan
- 6 Rack/tray support frames

1,2,3 Frame shelf



Description

2.2 Control panel

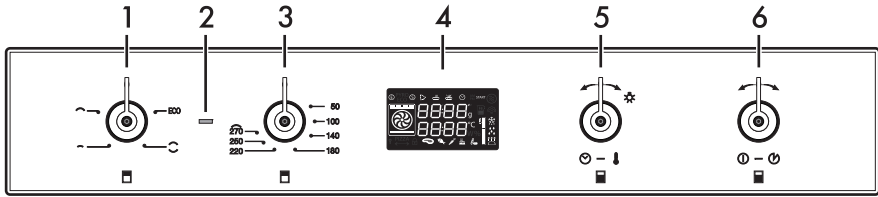

1 Auxiliary oven function knob

The oven's various functions are suitable for different cooking modes. After selecting the required function, set the cooking temperature using the temperature knob.

2 Auxiliary oven thermostat indicator light

The thermostat indicator light remains lit when the oven is heating up. Once the oven has reached the selected temperature the indicator light switches off.

3 Auxiliary oven temperature knob

This knob allows you to select the cooking temperature.

Turn the knob clockwise to the required value, between the minimum and maximum settings.

4 Main oven display

Displays the current time, the selected cooking temperature and function and any time set.

5 Main oven temperature knob

This knob allows you to select the cooking time and temperature, set programmed cooking and the current time as well as turn the light inside the oven on and off.

6 Main oven function knob

This knob allows you to turn the appliance on and off and select the cooking function.

2.3 5 Other parts

Shelves

The appliance features shelves for positioning trays and racks at different heights. The insertion heights are indicated from the bottom upwards (see 2.1 General Description).

Cooling fan

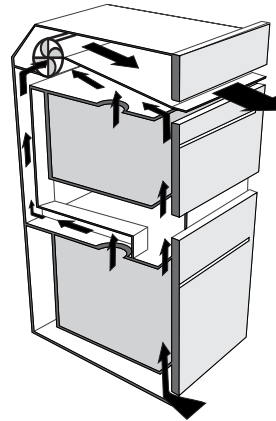

The fan cools the oven and comes into operation during cooking.



The fan causes a steady outflow of air from above the door which may continue for a brief period of time even after the appliance has been turned off.

Interior lighting

The oven light comes on when the door is opened or any function is selected. Turn the temperature knob briefly to the right to activate or deactivate internal lighting.

2.4 Available accessories



Some models are not provided with all accessories.

Racks

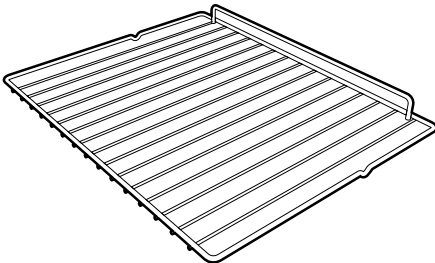

Useful for supporting containers with food during cooking.

Tray rack

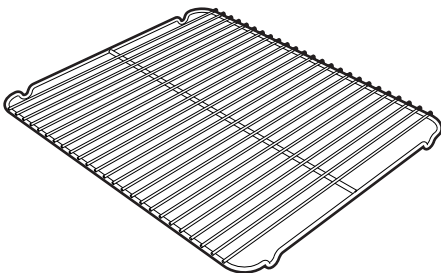

To be placed over the top of the oven tray; for cooking foods which may drip.

Deep tray

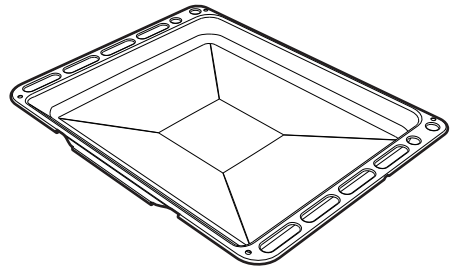

Useful for collecting fat from foods placed on the rack above and for cooking pies, pizzas and baked desserts.

Self-cleaning panels

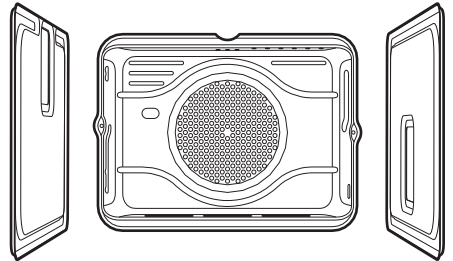

Useful for absorbing small grease residues.



The oven accessories intended to come into contact with food are made of materials that comply with the provisions of current legislation.



Original supplied and optional accessories can be requested to Authorised Assistance Centres. Use only original accessories supplied by the manufacturer.



3 Use

3.1 Instructions



High temperature inside the oven during use

Danger of burns

- Keep the oven door closed during cooking.
- Protect your hands wearing heat resistant gloves when moving food inside the oven.
- Do not touch the heating elements inside the oven.
- Do not pour water directly onto very hot trays.
- Do not allow children to get near the oven when it is in operation.



High temperature inside the oven during use

Danger of fire or explosion

- Do not spray any spray products near the oven.
- Do not use or leave flammable materials near the oven.
- Do not use plastic kitchenware or containers when cooking food.
- Do not put sealed tins or containers in the oven.
- Do not leave the oven unattended during cooking operations where fats or oils could be released.
- Remove all trays and racks which are not required during cooking.



Improper use

Risk of damage to enamelled surfaces

- Do not cover the bottom of the cooking compartment with aluminium or tin foil sheets.
- If you wish to use greaseproof paper, place it so that it will not interfere with the hot air circulation inside the oven.
- Do not place pans or trays directly on the bottom of the cooking compartment.
- Do not pour water directly onto very hot trays.

3.2 First use

1. Remove any protective film from the outside or inside of the appliance, including accessories.
2. Remove any labels (apart from the technical data plate) from the accessories and from the cooking compartment.
3. Remove and wash all the appliance accessories (see 4 Cleaning and maintenance).
4. Heat the empty oven at the maximum temperature to burn off any residues left by the manufacturing process.



3.3 Using the accessories

Racks and trays

Racks and trays have to be inserted into the side guides until they come to a complete stop.

- The mechanical safety locks that prevent the rack from being taken out accidentally have to face downwards and towards the oven back.

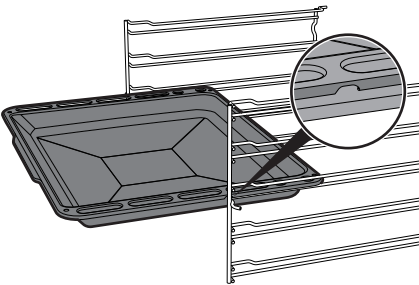
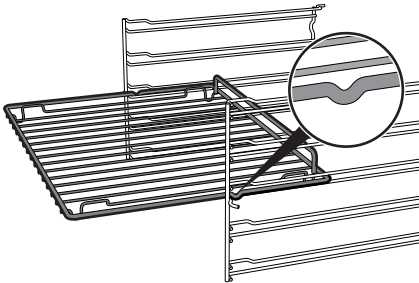

Gently insert racks and trays into the oven until they come to a stop.



Clean the trays before using them for the first time to remove any residues left by the manufacturing process.

Tray rack

The tray rack has to be inserted into the tray. In this way fat can be collected separately from the food which is being cooked.

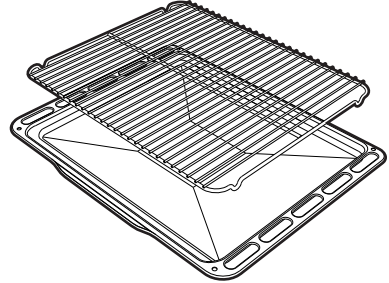

3.4 Auxiliary oven



The two ovens can be used at the same time, except for the Pyrolytic function.

To switch the auxiliary oven on:

- Select the cooking function using the function knob.
- Select the temperature using the temperature knob.



Use

3.5 Main oven with display

i The display only refers to the main oven. It has no control of the auxiliary oven.

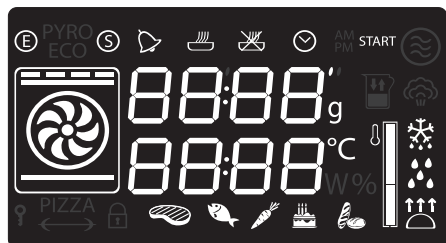

- Clock indicator light
- Minute minder timer indicator light
- Timed cooking with delayed start indicator light
- Timed cooking indicator light
- Showroom indicator light
- Eco logic indicator light
- Temperature level reached

Operating modes

Stand-by: When no function is selected, the display shows the current time and the symbol.



ON: When a function is activated, the display shows the parameters set such as temperature, duration and temperature reached.

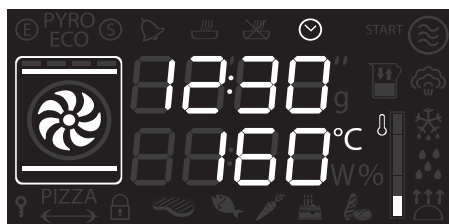

Each time the temperature knob is pressed during a function, the parameters will be cycled through in the following order.

In all modes it is possible to modify the value by turning the temperature knob to the left or right. Keep the knob turned to produce a faster increase or decrease.



1. Temperature
2. Minute minder timer duration
3. Function duration
4. Programmed cooking duration (if timed cooking has been selected)
5. Time display

Setting the time

On the first use, or after a power failure, **00:00** will be flashing on the appliance's display. To be able to start any cooking function, the current time must be set.

1. Turn the temperature knob to set the displayed time (keep the knob turned to produce a faster increase or decrease).
2. Press the temperature knob.
3. Turn the temperature knob to set the minutes (keep the knob turned to produce a faster increase or decrease).
4. Press the temperature knob to finish adjustment.



It may become necessary to change the current time, for example for daylight saving time. From the stand-by position, keep the temperature knob turned to the right or left until the hours flash.

It is not possible to change the time if the oven is **ON**.

Cooking functions



1. Select a traditional cooking function with the function knob.
2. Press the temperature knob if you wish to change the default temperature.
3. Turn the knob to set the temperature.
4. Press the function knob to start traditional cooking.

Preheating stage

In the combined and traditional functions, cooking itself is preceded by a preheating stage, which allows the oven to reach the cooking temperature more quickly.

The temperature level reached indication flashes to indicate that this stage is in progress.



When the preheating stage is complete, temperature level reached indication will remain lit steadily and a buzzer sounds to indicate that the food can be placed inside the oven.



Cooking can be interrupted at any time by pressing and holding the function knob down for at least 3 seconds.



Functions list

Eco



The combination of the fan and the circulaire heating element, in ECO mode, is particularly indicated for cooking on a single shelf, with reduced power consumption.

ECO



Static

As the heat comes from above and below at the same time, this system is particularly suitable for certain types of food. Traditional cooking, also known as static cooking, is suitable for cooking just one dish at a time. Perfect for all types of roasts, bread and cakes, and in any case, particularly suitable for fatty meats such as goose and duck.



Grill

The heat coming from the grill element gives perfect grilling results above all for thin and medium thickness meat and, in combination with the rotisserie (where fitted), gives the food an even browning at the end of cooking. Perfect for sausages, spare ribs and bacon. This function enables large quantities of food, particularly meat, to be grilled evenly.



Lower element

The heat coming just from the bottom allows you to complete the cooking of foods that require a higher bottom temperature, without affecting their browning. Perfect for cakes, pies, tarts and pizzas.



Fan assisted

The operation of the fan, combined with traditional cooking, ensures consistent cooking even with complex recipes. Perfect for biscuits and cakes, even when simultaneously cooked on several levels. (For multiple-level cooking, we recommend using the 2nd and 4th shelves).



Fan with grill

The air produced by the fan softens the strong heatwave generated by the grill, grilling perfectly even very thick foods. Perfect for large cuts of meat (e.g. shin of pork).



Fan + bottom

The combination of the fan with just the lower heating element allows cooking to be completed more rapidly. This system is recommended for sterilising or for finishing off the cooking of foods which are already well-cooked on the surface, but not inside, which therefore need a little more heat. Perfect for any type of food.



Circulaire

The combination of the fan and the circulaire heating element (incorporated in the rear of the oven) allows you to cook different foods on several levels, as long as they need the same temperatures and type of cooking. Hot air circulation ensures instant and even distribution of heat. It will be possible, for instance, to cook fish, vegetables and biscuits simultaneously (on different levels) without odours and flavours mingling.



Turbo

The combination of fan assisted cooking and traditional cooking allows different foods to be cooked on several levels extremely quickly and efficiently, without odours and flavours mingling. Perfect for large volumes that call for intense cooking.



Small grill

Using only the heat released from the central element, this function allows you to grill small portions of meat and fish for making kebabs, toasted sandwiches and any types of grilled vegetable side dishes.

Minute minder





This function only activates the buzzer, without stopping cooking.

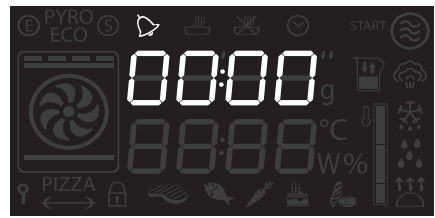

The minute minder can be activated both during cooking and when the appliance is in standby.

1. Press the temperature knob once (twice if cooking is already in progress). The display shows **00:00** and the  indicator light flashes.



2. Turn the knob to set the duration (from 1 minute to 4 hours). After a few seconds, the  indicator light stops flashing and the countdown starts.
3. Select the required cooking function and wait for the buzzer to sound, indicating that the cooking time is over. The  indicator light flashes.
4. Turn the knob to select another minute minder. Or else press the temperature knob to stop the buzzer.



You must set the value to zero to remove the minute minder.



Use

Timed cooking

i Timed cooking is the function which allows a cooking operation to be started and then ended after a specific length of time set by the user.

i Activation of timed cooking cancels any minute minder timer which may previously have been set.

1. After selecting a cooking function and temperature, press the temperature knob three times. The display shows **00:00** and the indicator light flashes.

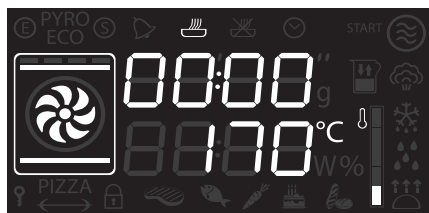

2. Turn the temperature knob right or left to set the cooking duration from 00:01 to 12:59. Keep the knob turned to produce a faster increase or decrease.

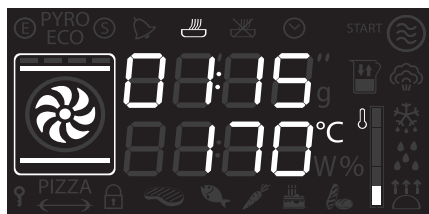

3. A few seconds after the required duration is set, the indicator light stops flashing and timed cooking starts.
4. At the end of the cooking time STOP appears on the display and a buzzer sounds that can be deactivated by pressing the temperature knob.



To select a further timed cooking, turn the temperature knob right or left again.



To extend the cooking time manually, press the temperature knob again. The appliance resumes its normal operation with the previously selected cooking settings.

Press and hold the function knob down to switch off the appliance.



Modifying the data set during timed cooking

During operation, it is possible to modify timed cooking duration:

1. When the  indicator light is steady and cooking is in progress inside the appliance, press the temperature knob twice. The  indicator light starts flashing.
2. Turn the temperature knob right or left to alter the pre-set cooking time.

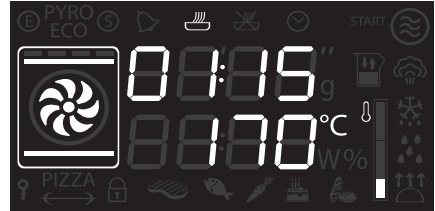

2. Turn the knob right or left to set the cooking duration from 00:01 to 12:59. Keep the knob turned for a fast increase or decrease.



Programmed cooking

i Programmed cooking is the function which allows cooking to be stopped at an established time depending on the time set by the user, after which the oven will switch off automatically.

1. After selecting a cooking function and temperature, press the temperature knob three times. The display shows **00:00** and the  indicator light flashes.

3. Press the temperature knob a fourth time. The  indicator light flashes. Turn the knob right or left to set the cooking end time.
4. After a few seconds the  and  indicator lights stop flashing. The appliance waits for the set start time.

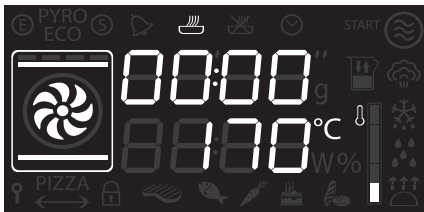



5. At the end of the cooking time STOP appears on the display and a buzzer sounds that can be deactivated by pressing the temperature knob.

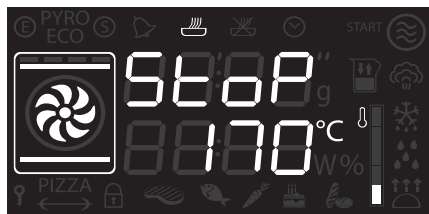

Modifying the data set during programmed cooking



After modifying the cooking duration, the end of cooking time must be re-set.

During operation, it is possible to modify programmed cooking duration:

1. When the and indicator lights are lit steadily and the appliance is waiting for cooking to start, press the temperature knob twice. The indicator light starts flashing.
2. Turn the temperature knob right or left to alter the pre-set cooking time.
3. Press the temperature knob again. The indicator light switches off and the indicator light starts flashing. The display shows the cooking end time.
4. Turn the temperature knob right or left to delay the cooking end time.
5. After a few seconds the and indicator lights stop flashing and programmed cooking restarts its operation with the new settings.



To extend the cooking time manually, press the temperature knob again. The appliance resumes its normal operation with the previously selected cooking settings.



Press and hold the function knob down to switch off the appliance.



For safety reasons, it is not possible to set the end of cooking time by itself without setting the cooking duration.



3.6 Cooking advice

General advice

- Use a fan assisted function to achieve consistent cooking at several levels.
- It is not possible to shorten cooking times by increasing the temperature (the food could be overcooked on the outside and undercooked on the inside).

Advice for cooking meat

- Cooking times vary according to the thickness and quality of the food and to consumer taste.
- Use a meat thermometer when roasting meat, or simply press on the roast with a spoon. If it is hard, it is ready; If not, it needs another few minutes cooking.

Advice for cooking with the Grill and the Fan with grill

- Meat can be grilled even when it is put into the cold oven or into the preheated oven if you wish to change the effect of the cooking.
- With the Fan with grill function, we recommend that you preheat the oven before grilling.
- We recommend placing the food at the centre of the rack.

Advice for cooking desserts/pastries and biscuits

- Use dark metal moulds: They help to absorb the heat better.
- The temperature and the cooking time depend on the quality and consistency of the dough.

- To check whether the dessert is cooked right through: At the end of the cooking time, put a toothpick into the highest point of the dessert. If the dough does not stick to the toothpick, the dessert is cooked.
- If the dessert collapses when it comes out of the oven, on the next occasion reduce the set temperature by about 10°C, selecting a longer cooking time if necessary.

Advice for defrosting and proving

- Place frozen foods without their packaging in a lidless container on the first shelf of the oven.
- Avoid overlapping the food.
- To defrost meat, use the rack placed on the second level and a tray on the first level. In this way, the liquid from the defrosting food drains away from the food.
- The most delicate parts can be covered with aluminium foil.
- For successful proving, a container of water should be placed in the bottom of the oven.

To save energy

- Stop cooking a few minutes before the time normally used. Cooking will continue for the remaining minutes with the heat which has accumulated inside the oven.
- Reduce any opening of the door to a minimum to avoid heat dispersal.
- Keep the inside of the appliance clean at all times.
- (Where fitted) When it is not being used, remove the pizza plate and put the cover back in its slot.



3.7 Special functions and automatic programs

Timed defrosting

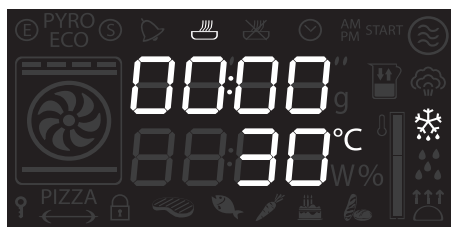

1. Place the food inside the oven.
2. Select the timed defrosting function, indicated by the  symbol, using the function knob.
3. Press the temperature knob to set the duration.
4. Turn the knob to adjust the value (from 5 seconds to 99 minutes).
5. Press the function knob to start defrosting.
6. At the end, the word STOP will be displayed.

Proving



It is not possible to modify the temperature of the proving function.



For successful proving, a container of water should be placed in the bottom of the oven.

1. Position the dough for proving on the second shelf.
2. Press the function knob to select and activate proving.
3. At the end of preheating, the text "START" flashes.
4. Put the food to cook into the oven and press the function knob to start cooking.



Shabbat

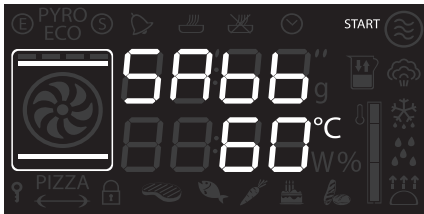

This function allows food to be cooked in accordance with the provisions of the Jewish religion day of rest.



This function results in the appliance operating in a particular way:

- Cooking can proceed indefinitely, it is not possible to set any time.
- No preheating will be performed.
- The cooking temperature which can be selected varies between 60-100 °C.
- The oven light remains turned off, any action such as opening the door or manually activating the oven does not turn the lamp on.
- The internal fan remains turned off.
- Knob illumination and audible prompts remain disabled.



After activating the Shabbat function the settings cannot be altered.

Any action on the knobs will produce no effect; only the function knob remains active to allow the appliance to be turned off.

1. Press the function knob to select the Shabbat function.
2. Press the temperature knob.
3. Turn the temperature knob to change the re-heating time.
4. Press the function knob to confirm the settings and start the Shabbat function.
5. Once completed press and hold the function knob down for at least 3 seconds to turn the appliance off.



Use





Defrosting by weight



i This function defrosts foods on the basis of the type and weight of the frozen product.

1. Place the food inside the oven.
2. Press the function knob to select defrosting by weight, marked by "dE00" and the illuminated food symbols.
3. Turn the function knob to select the type of food to defrost.
4. Turn the temperature knob to select the weight (in grams) of the food to defrost.
5. Press the function knob to confirm the parameters and start defrosting.
6. At the end, the word STOP will be displayed.

Preset parameters:

dE	Type	Weight (g)	Time (min)
01	 Meat	500	105
02	 Fish	400	40
03	 Fruit	300	45
04	 Bread	300	20

Automatic programs



The automatic cooking programs are divided by the type of food to be cooked.

1. Press the function knob to select cooking with automatic programs.
2. Turn the function knob to select the required program (see Automatic programs table).



Automatic programs table



The times indicated in the tables do not include the preheating times.



MEATS (01 - 05)

Subcategory	Weight (g)	Level	Function	Temp. (°C)	Time (minutes)
01 Roast beef	1000	2	Circulaire	200	50
02 Pork loin	1000	2	Turbo	190	75
03 Lamb	1000	2	Turbo	190	100
04 Veal	1000	2	Fan assisted	190	65
05 Roast chicken	1000	2	Turbo	200	64



FISH (06 - 07)

Subcategory	Weight (g)	Level	Function	Temp. (°C)	Time (minutes)
06 Fresh fish	500	2	Fan assisted	160	35
07 Frozen fish	500	2	Circulaire	160	45



VEGETABLES (08 - 10)

Subcategory	Weight (g)	Level	Function	Temp. (°C)	Time (minutes)
08 Mixed grilled	500	4	Grill	250	25
09 Roasted	1000	2	Circulaire	200	45
10 Roast potatoes	1000	2	Turbo	220	40



DESSERTS (11 - 13)

Subcategory	Weight (g)	Level	Function	Temp. (°C)	Time (minutes)
11 Biscuits	600	2	Turbo	160	18
12 Muffins	500	2	Circulaire	160	18
13 Tart	800	2	Static	170	40



Use



BREAD - PIZZA - PASTA (14-20)

	Subcategory	Weight (g)	Level	Function	Temp. (°C)	Time (minutes)
14	Leavened bread	1000	2	Circulaire	200	30
15	Pan baked pizza	1000	1	Fan assisted	280	7
16	Stone baked pizza	500	1	Fan assisted	280	4
17	Pasta bake	200	1	Static	220	40
18	Lasagne	200	1	Static	230	35
19	Paella	500	2	Fan assisted	190	25
20	Quiche	1000	1	Static	200	40

3.8 Secondary menu

The appliance also has a drop-down secondary menu allowing the user to:

- Activate or deactivate Showroom mode (which disables all the heating elements so that only the control panel works).
- Activate or deactivate Low Power mode (Eco-Logic).
- (some models only)
Activate or deactivate Keep Warm mode.
- Activate or deactivate light timing (Eco light).

With the appliance in Stand-By status

1. Activate the internal light by turning the temperature knob quickly.
2. Press and hold the temperature knob down for at least 5 seconds.
3. Turn the temperature knob right or left to change the setting status (ON/OFF).
4. Press the temperature knob to move to the next mode.



Child Lock mode: This mode allows the appliance to lock the controls automatically after one minute of normal operation without any intervention from the user.

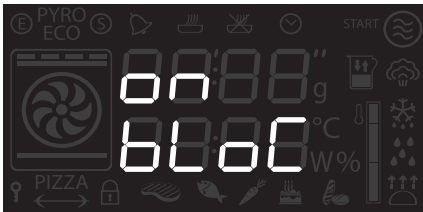
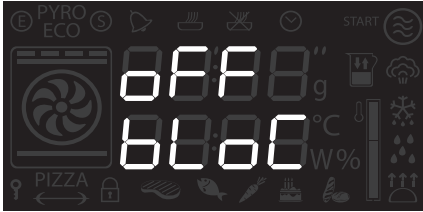

During normal operation it is indicated by the  indicator light coming on.

To release the lock temporarily during cooking, hold the temperature knob down for 5 seconds. One minute after the last setting the lock will become active again.



Touching or varying the position of the temperature and function knobs, the display will show "bloc" for two seconds.



It is still possible to turn the appliance off instantaneously by pressing and holding the function knob for 3 seconds when in child lock mode.

Showroom mode (for exhibitors only):

This mode allows the appliance to deactivate all heating elements, while keeping the control panel active.

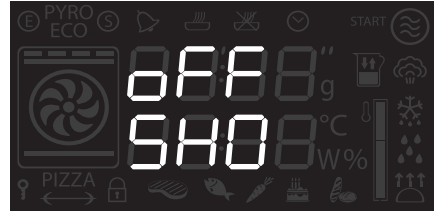

To use the appliance normally, set this mode to OFF.



If the mode is active, the  indicator light lights up on the display.

Low Power mode: This mode allows the appliance to limit the power used. Indicated for use of multiple appliances at the same time on circuits with limited maximum power.

HI: normal power.

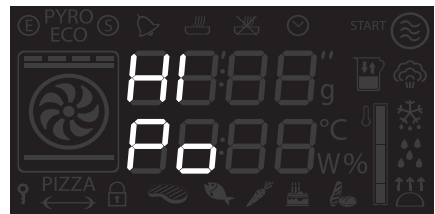



Use

LO: low power.

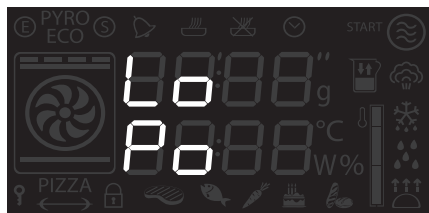

Light timing mode

For greater energy savings, the light is automatically deactivated one minute from the start of cooking.



To stop the appliance from automatically deactivating the light after one minute, set this mode to OFF.



The manual off/on control is always available with both settings by turning the temperature knob to the right.



Activating low power mode means that preheating and cooking times may be extended.



If the mode is active, the **E** indicator light lights up on the display.

Keep Warm Mode (some models only):

This mode allows the appliance to keep cooked food warm (at low temperatures) for around an hour after cooking finishes with a cooking cycle for which a duration has been set (if this is not manually interrupted).





Auxiliary oven cooking information table

Food	Weight (Kg)	Function	Runner position from the bottom	Temperature (°C)	Time (minutes)	
Lasagne	3 / 4	Static	1 or 2	220 - 230	50 - 60	
Pasta bake	2	Static	1 or 2	220 - 230	40	
Roast veal	1	Static	2	180 - 190	70 - 80	
Pork loin	1	Static	2	180 - 190	70 - 80	
Pork shoulder	1	Static	2	180 - 190	90 - 100	
Roast rabbit	1	Static	2	180 - 190	70 - 80	
Turkey breast	1.5	Static	2	180 - 190	89 - 90	
Roast chicken	1	Static	2	190 - 200	55 - 60	
					1st surface	2nd surface
Pork chops	1	Grill	4	250 - 280	7 - 9	5 - 7
Pork fillet	1	Grill	3	250 - 280	9 - 11	5 - 9
Sausages	1	Grill	3	250 - 270	7 - 9	5 - 6
Bacon	0.8	Grill	1/2/3/4	270	6 - 7	3 - 4
Salmon trout	1	Static	1	250 - 270	14 - 16	
Pizza	1	Static	1	280	8	
Focaccia	0.8	Static	2	180 - 190	15 - 20	
Fruit tart		Static	1	170 - 180	35 - 40	
Short pastry		Static	1	170 - 180	20 - 25	
Rice pudding	1	Static	1	170 - 180	50 - 60	
Apple pie	0.5	Static	2	180	60	

The times indicated in the table do not include preheating times and are provided as a guide only.



Cleaning and maintenance

4 Cleaning and maintenance

4.1 Instructions



Improper use
Risk of damage to surfaces

- Do not use steam jets for cleaning the appliance.
- Do not use cleaning products containing chlorine, ammonia or bleach on steel parts or parts with metallic finishes on the surface (e.g. anodizing, nickel- or chromium-plating).
- Do not use abrasive or corrosive detergents on glass parts (e.g. powder products, stain removers and metallic sponges).
- Do not use rough or abrasive materials or sharp metal scrapers.

4.2 Cleaning the surfaces

To keep the surfaces in good condition, they should be cleaned regularly after use. Let them cool first.

4.3 Ordinary daily cleaning

Always use only specific products that do not contain abrasives or chlorine-based acids.

Pour the product onto a damp cloth and wipe the surface, rinse thoroughly and dry with a soft cloth or a microfibre cloth.

4.4 Food stains or residues

Do not use metallic sponges or sharp scrapers as they will damage the surfaces. Use ordinary non-abrasive products with the aid of wooden or plastic utensils if necessary. Rinse thoroughly and dry with a soft cloth or a microfibre cloth.

Do not allow residues of sugary foods (such as jam) to set inside the oven. If left to set for too long, they might damage the enamel lining of the oven.

4.5 Removing the door

For easier cleaning, the door can be removed and placed on a canvas.

To remove the door proceed as follows:

1. Open the door completely and insert two pins into the holes on the hinges indicated in the figure.

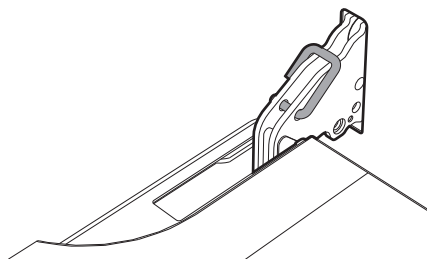



2. Grasp the door on both sides with both hands, lift it forming an angle of around 30° and remove it.

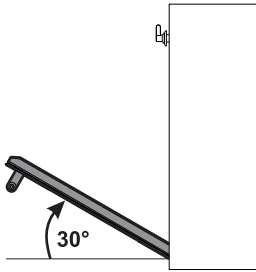

3. To reassemble the door, put the hinges in the relevant slots in the oven, making sure that grooved sections **A** are resting completely in the slots. Lower the door and once it is in place remove the pins from the holes in the hinges.

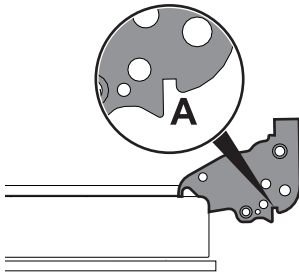

4.6 Cleaning the door glazing

The glass in the door should always be kept thoroughly clean. Use absorbent kitchen roll. In case of stubborn dirt, wash with a damp sponge and an ordinary detergent.



We recommend the use of cleaning products distributed by the manufacturer.

4.7 Removing the internal glass panels

For easier cleaning the door internal glass panels can be disassembled.

1. Remove the internal glass panel by pulling the rear part gently upwards, following the movement indicated by the arrows (1).
2. Then, pull the front part upwards (2). In this way, the 4 pins attached to the glass detach from their housings in the oven door.

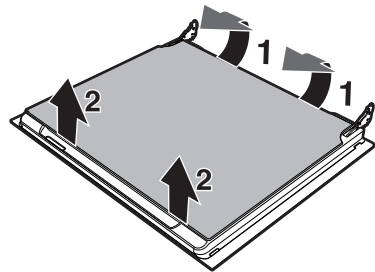

3. Some models have an intermediate glass panel. Remove the intermediate glass panel by lifting it upwards.



Cleaning and maintenance

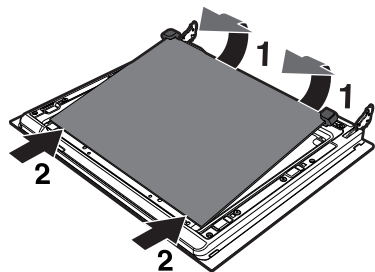

5. Clean the external glass panel and the panels previously removed. Use absorbent kitchen roll. In case of stubborn dirt, wash with a damp sponge and neutral detergent.

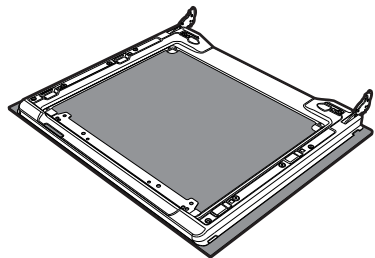

6. Refit the panels in the reverse order in which they were removed.
7. Reposition the internal glass panel. Take care to centre and insert the 4 pins into their housings in the oven door by applying slight pressure.

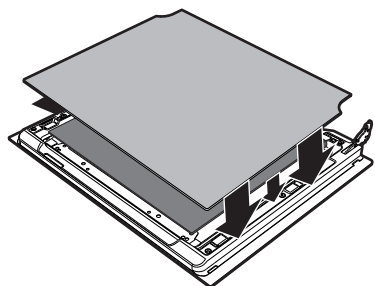

4.8 Cleaning the inside of the oven

For the best oven upkeep, clean it regularly after having allowed it to cool.

Take out all removable parts.



Clean the oven racks with warm water and non-abrasive detergent. Carefully rinse and dry the damp parts.



The oven should be operated at the maximum temperature for about 15-20 minutes after the use of specific products, to burn off the residues left inside the oven.



For easier cleaning, remove the door.



Removing racks/trays support frames

Removing the guide frames enables the sides to be cleaned more easily. This operation should be performed each time the automatic cleaning cycle is used (on some models only).

To remove the guide frames: Pull the frame towards the inside of the oven to unhook it from its groove **A**, then slide it out of the seats **B** at the back.

When cleaning is complete, repeat the above procedures to put the guide frames back in.

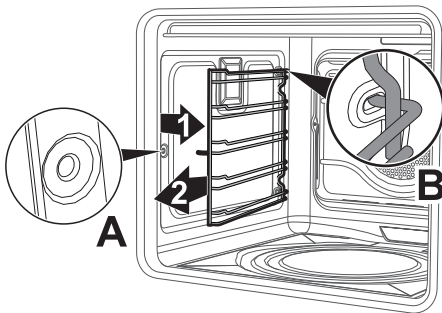

Regeneration of self-cleaning panels (catalysis cycle)

The regeneration cycle of the self-cleaning panels is a cleaning method through heating suitable for removing small grease residues, not sugar-based ones.

1. Clean the base and the roof liner first with a microfibre cloth soaked in water and neutral washing up liquid. Rinse thoroughly.
2. Set a regeneration cycle by selecting a fan-assisted function at the maximum temperature for one hour.
3. If the panels are particularly dirty after the regeneration cycle, remove them and wash them with neutral washing up liquid. Rinse and dry them.
4. Put the panels back in the oven and set a fan-assisted function at a temperature of 180°C for one hour, in order to ensure that they are thoroughly dry.



We recommend carrying out the self-cleaning panel regeneration cycle every 15 days.



Cleaning and maintenance

4.9 Vapor Clean: Assisted oven cleaning (main oven only)



Vapor Clean is an assisted cleaning procedure which facilitates the removal of dirt. Thanks to this process, it is possible to clean the inside of the oven very easily. The dirt residues are softened by the heat and water vapour for easier removal afterwards.



Improper use Risk of damage to surfaces

- Remove any food residues or large spills from previous cooking operations from the inside of the oven.
- Carry out assisted oven cleaning operations only when the oven is cold.

Preliminary operations

Before starting the Vapor Clean function:

- Completely remove all accessories from inside the oven. The upper guard can be left inside the oven.
- Pour approx. 40 cc of water onto the floor of the oven. Make sure it does not overflow out of the cavity.

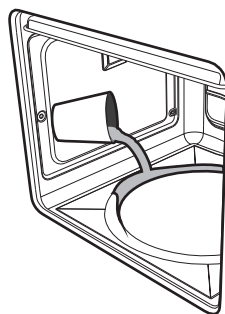

- Spray a water and washing up liquid solution inside the oven using a spray nozzle. Direct the spray against the side walls, upwards, downwards and towards the deflector.

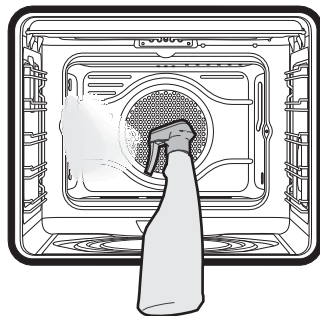

- Close the door.



We recommend spraying approx. 20 times at the most.



Vapor Clean setting

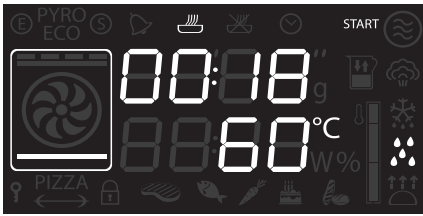

If the internal temperature is greater than that required for the Vapor clean function, the cycle will be stopped immediately and STOP will appear on the display. Let the appliance cool down before activating the assisted cleaning cycle.

1. Select the  symbol using the function knob.
2. The duration and temperature of the cleaning cycle will appear on the display.
3. Press the temperature knob to start the cycle.
4. A buzzer will indicate the end of the Vapor Clean cycle.



The temperature and time parameters cannot be modified by the user.

End of the Vapor Clean cycle

1. Open the door and wipe away the less stubborn dirt with a microfibre cloth.
2. Use an anti-scratch sponge with brass filaments on tougher encrustations.
3. In case of grease residues use specific oven cleaning products.
4. Remove the water left inside the oven.

For improved hygiene and to avoid food being affected by any unpleasant odours, we recommend that the oven is dried using a fan assisted function at 160°C for approximately 10 minutes.



We recommend wearing rubber gloves for these operations.



For easier manual cleaning of the parts difficult to reach, we recommend removing the door.



Cleaning and maintenance

4.10 Extraordinary maintenance



Live parts
Danger of electrocution

- Disconnect the oven power supply.

Replacing the internal light bulb

1. Completely remove all accessories from inside the oven.
2. Remove the racks/trays support frames.
3. Remove the bulb cover using a tool (e.g. a screwdriver).

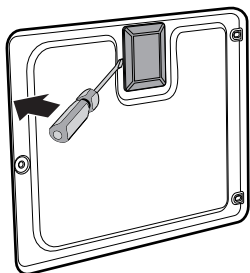

4. Slide out and remove the lamp.

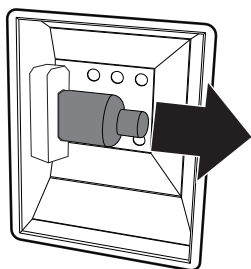

Do not touch the halogen lamp directly with your fingers, but wrap it in an insulating material.

5. Replace the lamp with one of the same type (40W).
6. Refit the cover correctly, so that the moulded part of the glass is facing the door.
7. Press the cover completely down so that it attaches perfectly to the bulb support.

Removing the door seal

To permit thorough cleaning of the oven, the door seal may be removed. There are fasteners on all four sides to attach it to the edge of the oven. Pull the 4 edges of the seal outwards to detach the fasteners.

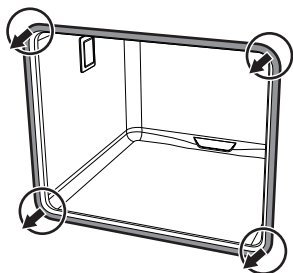



5 Installation

5.1 Electrical connection



**Power voltage
Danger of electrocution**

- Have the electrical connection performed by authorised technical personnel.
- The appliance must be connected to earth in compliance with electrical system safety standards.
- Disconnect the main power supply.

General information

Check the grid characteristics against the data indicated on the plate.

The identification plate bearing the technical data, serial number and brand name is visibly positioned on the appliance.

Do not remove this plate for any reason. The appliance works at 220-240 V~.

Use a three-core cable (3 x 1.5 mm² cable, referring to the cross section of the internal conductor).

Perform the ground connection using a wire that is 20 mm longer than the other wires.

Connection modes:

- 220-240 V 1N~

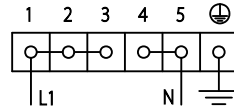

Use a **3 x 4 mm² three-core** cable.

- 380-415 V 2N~

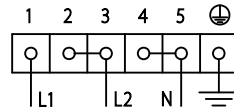

Use a **4 x 2.5 mm² four-core** cable.

- 380-415 V 3N~

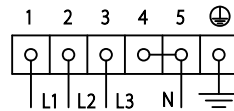

Use a **5 x 2.5 mm² five-core** cable.

Fixed connection

Fit the power line with an omnipolar circuit breaker in compliance with installation regulations.

The circuit breaker should be located near the appliance and in an easily reachable position.

Connection with plug and socket

Make sure that the plug and socket are of the same type.

Avoid using adapters and shunts as these could cause overheating and a risk of burns.



Installation

5.2 Cable replacement



Power voltage
Danger of electrocution

- Disconnect the main power supply.

1. Unscrew the fastening screws **2** of the terminal board cover.

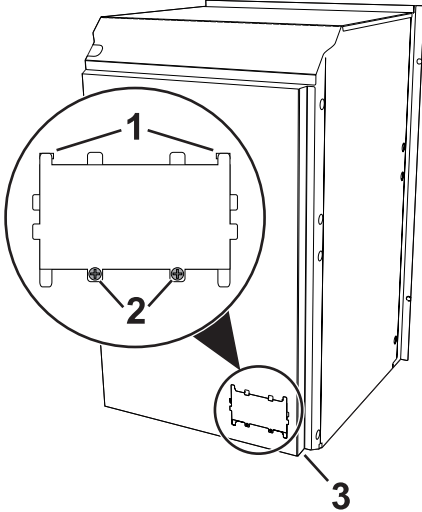

2. Slide the tabs **1** of the terminal board cover out of the grooves;
3. Loosen the screw of the cable retention bracket in the right lower part of the oven back **3**;
4. Make sure that the cables (for the oven or any hob) follow the best route in order to avoid any contact with the appliance.

5.3 Positioning



Heavy appliance
Danger of crush injuries

- Place the appliance into the piece of furniture with the aid of a second person.



Pressure on the open door
Risk of damages to the appliance

- Never use the oven door to lever the appliance into place when fitting.
- Avoid exerting too much pressure on the oven door when open.



Heat production during appliance operation
Risk of fire

- Check that the piece of furniture material is heat resistant.
- Check that the piece of furniture has the required slots.



Fixing

To secure the appliance to the counter, screw in 6 screws through the holes in the frame.

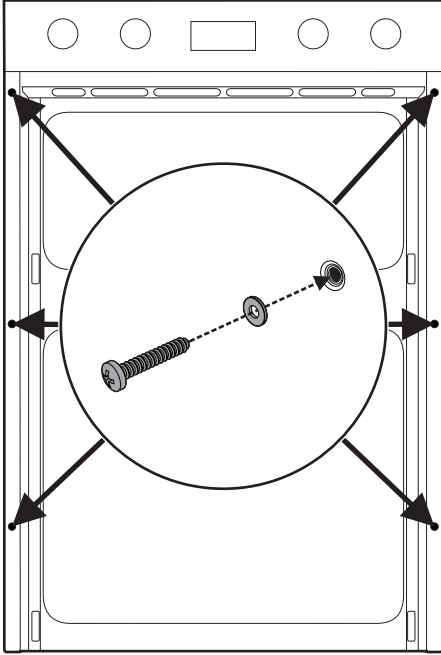

Mounting (mm)

The oven is designed for mounting into any piece of furniture as long as it is heat-resistant. Respect the unit dimensions and the oven overall dimensions for positioning. Depending on the type of installation a slot should be foreseen for ventilating the appliance.

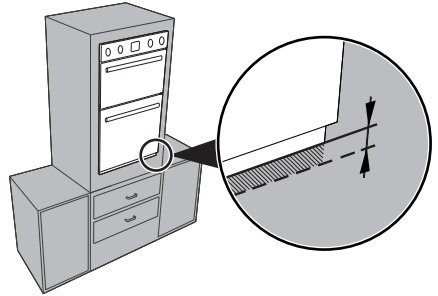

To be able to open the door completely, any unit protuberance should be at a distance of at least 1 cm from the oven.

Appliance overall dimensions (mm)

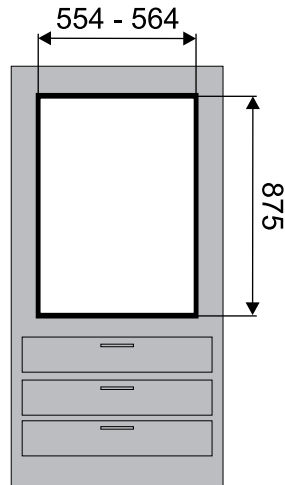
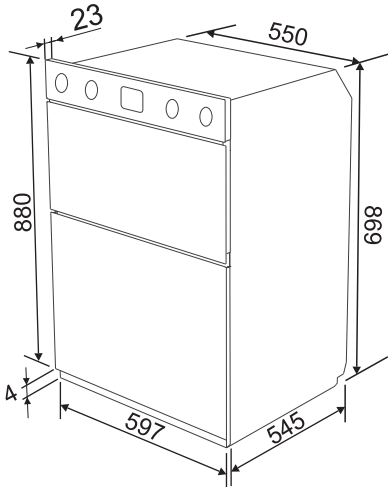



Installation

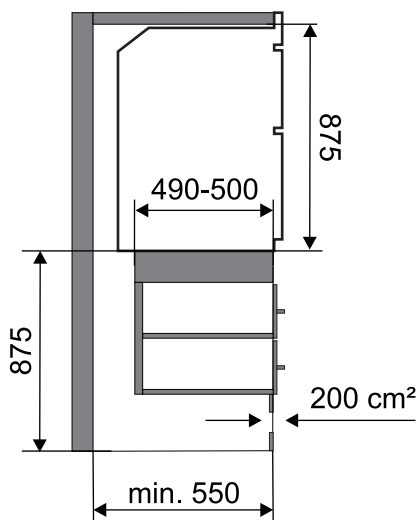

Create an opening with a total surface area of at least 200 cm² in the bottom front part of the unit.

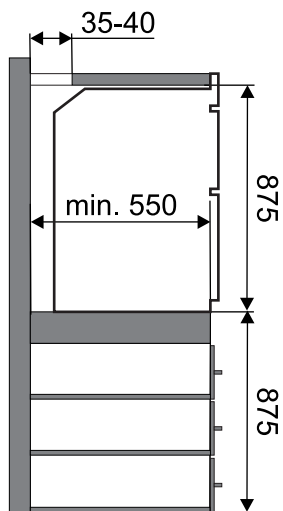

Create an opening 35-40 mm deep in the top rear part of the unit.



914776364/A