

2020

John Lewis

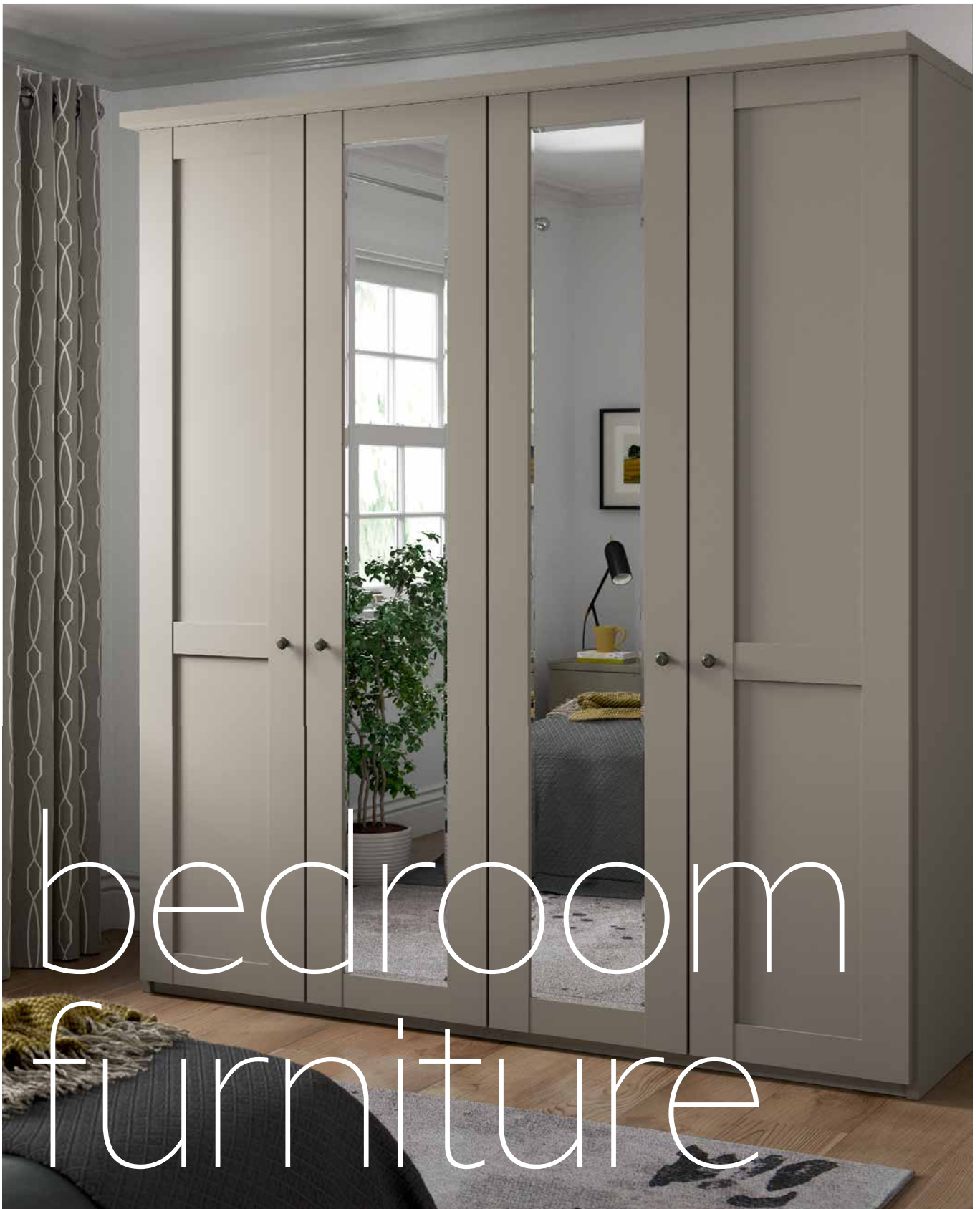

bedroom
furniture

Create your perfect bedroom

Your bedroom is your personal haven. At the end of every day you need not only a relaxing environment, but also furniture that looks great and makes the best use of your available space.

Choose from our range of modern and classic style wardrobes and furniture, which all have innovative storage solutions and include home delivery and assembly in your room as standard.

Our service

Choose

One of our store partners will help you choose from a wide variety of available furniture styles, finishes, door configurations and internal accessories.

Alternatively a selection can be seen online, visit johnlewis.com
Once you have decided, your furniture will be made to order.

Delivery and Assembly

Our assembly teams will contact you to book your delivery once your furniture is ready.

Our experienced fitters will deliver and assemble your furniture in your chosen room.

All packaging will be removed and your room left tidy, leaving you to enjoy your new bedroom straight away.

For peace of mind, all ranges in this brochure come with a 10-year guarantee.

Our ranges

Marlow	2
Elstra	6
Girona	10
Pirna	14
Jena	18

Marlow

The Marlow collection offers an elegant shaker style of wardrobe and is available in a choice of matt finishes: White, Havana and Pebble Grey



Key features

All wardrobes in this range come with two shelves and a hanging rail per internal compartment, and include soft close as standard



Wardrobe finishes

Door finishes

Choose from the available finishes below to match your bedroom style



Matt pebble grey

Matt Graphite



Matt pebble grey

Matt Graphite

Crystal mirror

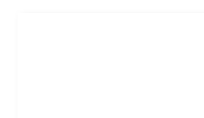

Matt white

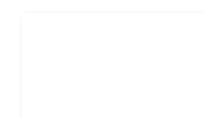

Matt white

Available sizes

Hinged door wardrobes have a depth of 58cm.

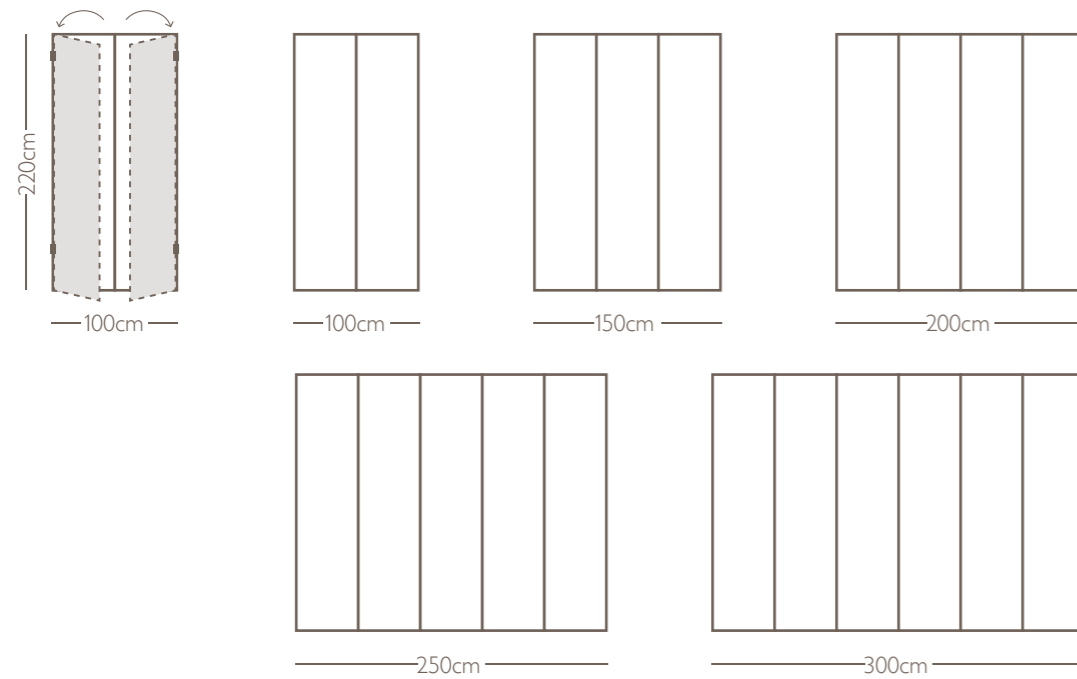

Door combinations

Door finishes can be combined in different ways when choosing your wardrobe. Examples shown below

Hinged door

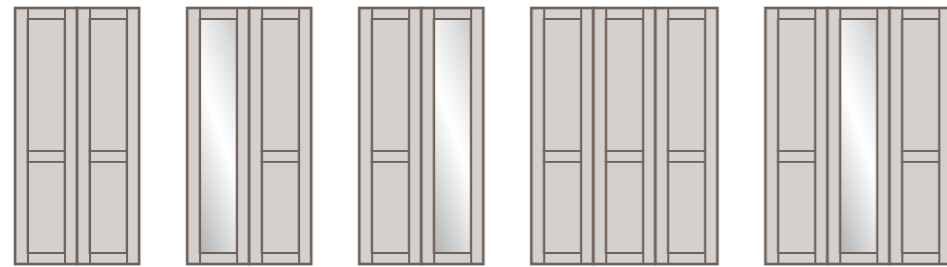

Matt painted Matt painted and mirror

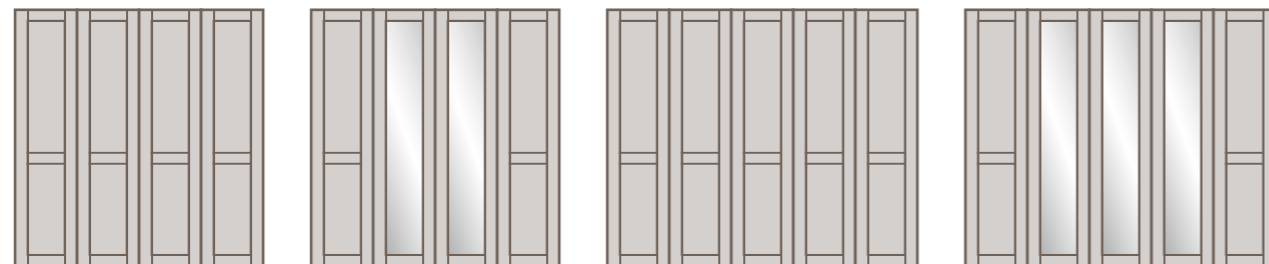

More options available, please speak to a store partner for more information

Choose your accessories

Maximise storage with additional shelves, rails, drawers and internal accessories. Finish off your wardrobe with internal or external LED lights



1. Set of 3 adjustable shelves
2. Clothes rail
3. Drawer insert with 2 pull-outs and glass front
4. Set of 2 or 3 LED strip lights
5. LED wardrobe interior lighting with motion detector

Not all accessories will fit the internal dimensions of all wardrobes; please check dimensions before ordering or ask a partner in store for further information

Complete your bedroom

Choose from furniture below (shown in pebble grey)



Bedside chest
3 drawers
W50 H57 D36cm

Bedside cabinet
4 drawers
W47 H86 D42cm

Chest of drawers
4 drawers
W75 H86 D42cm

Other finishes available

Chest and bedside finishes

Drawer finishes



Elstra

Combining style and functionality, the Elstra range of hinged and sliding door wardrobes when combined with matching furniture, gives a modern feel to your bedroom



Key features







All wardrobes in this range come with two shelves and a hanging rail per internal compartment. Only sliding door wardrobes come with soft close as standard

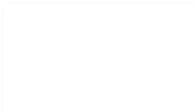
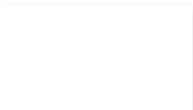
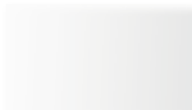

Wardrobe finishes

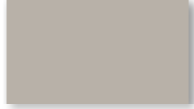
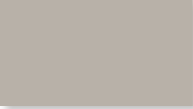
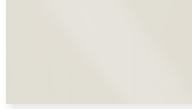
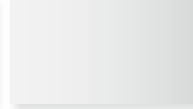
Door finishes

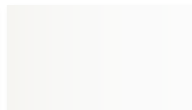
Choose from the available finishes below to match your bedroom style

			
Matt white	Matt white	White glass	Mirror
			
Matt pebble grey	Matt pebble grey	Pebble grey glass	Mirror
			
Bianco oak	Bianco oak	White glass	Mirror

Available sizes

Hinged door wardrobes – these have a depth of 58cm

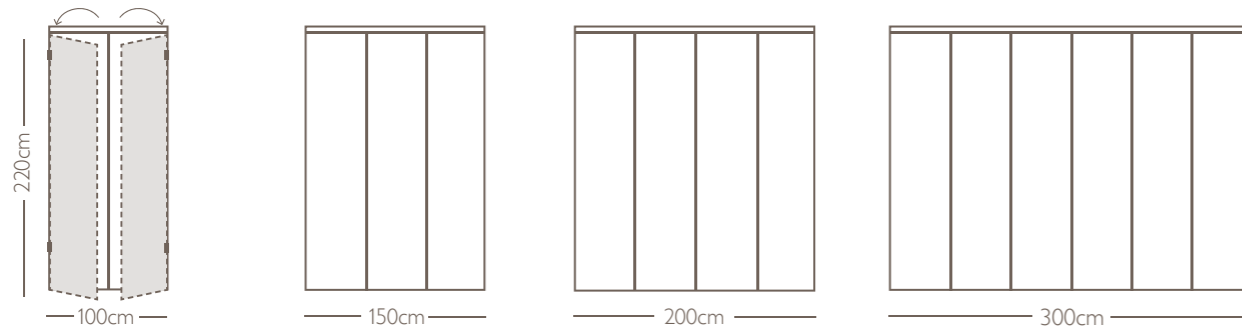

Sliding door wardrobes – these have a depth of 67cm

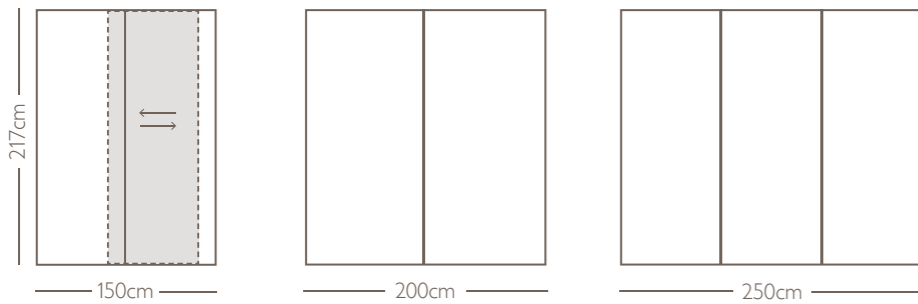

Door combinations

Door finishes can be combined in different ways when choosing your wardrobe as shown below

Hinged door

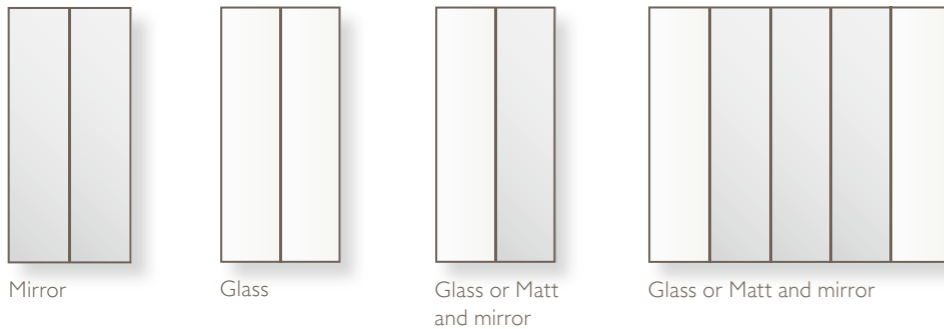

Sliding door

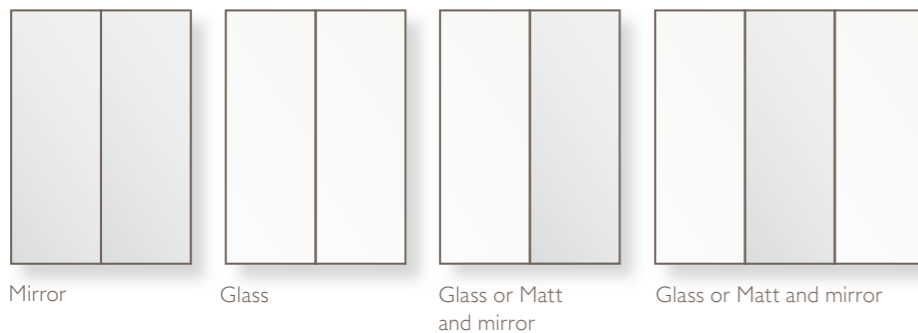

Choose your accessories

Maximise storage with additional shelves, rails, drawers and external LED Strip lighting



1. Additional hanging rail
2. Set of 3 additional shelves
3. Set of 2 internal drawers with glass front
4. Set of 2 or 3 LED lights
5. Side profiles

Not all accessories will fit the internal dimensions of all wardrobes; please check dimensions before ordering or ask a partner in store for further information

Complete your bedroom

Choose matching furniture below (shown in rustic oak with white glass)

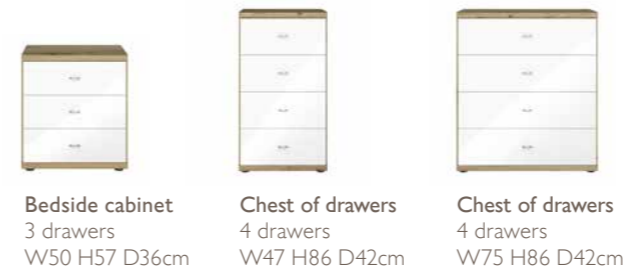

Bedside cabinet
3 drawers
W50 H57 D36cm

Chest of drawers
4 drawers
W47 H86 D42cm

Chest of drawers
4 drawers
W75 H86 D42cm

Other finishes available

Chest and bedside finishes



Drawer finishes

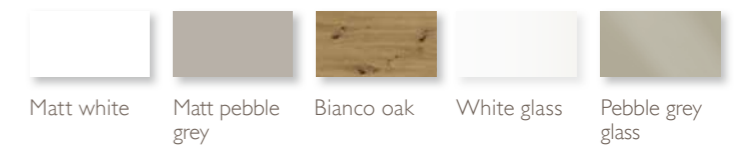

Girona

The Girona range of sliding and hinged wardrobes with a choice of integrated drawers provide flexible storage options whilst keeping a modern and minimalist look in your bedroom



Key features

All wardrobes in this range come with two shelves and a hanging rail per internal compartment, and include soft close as standard

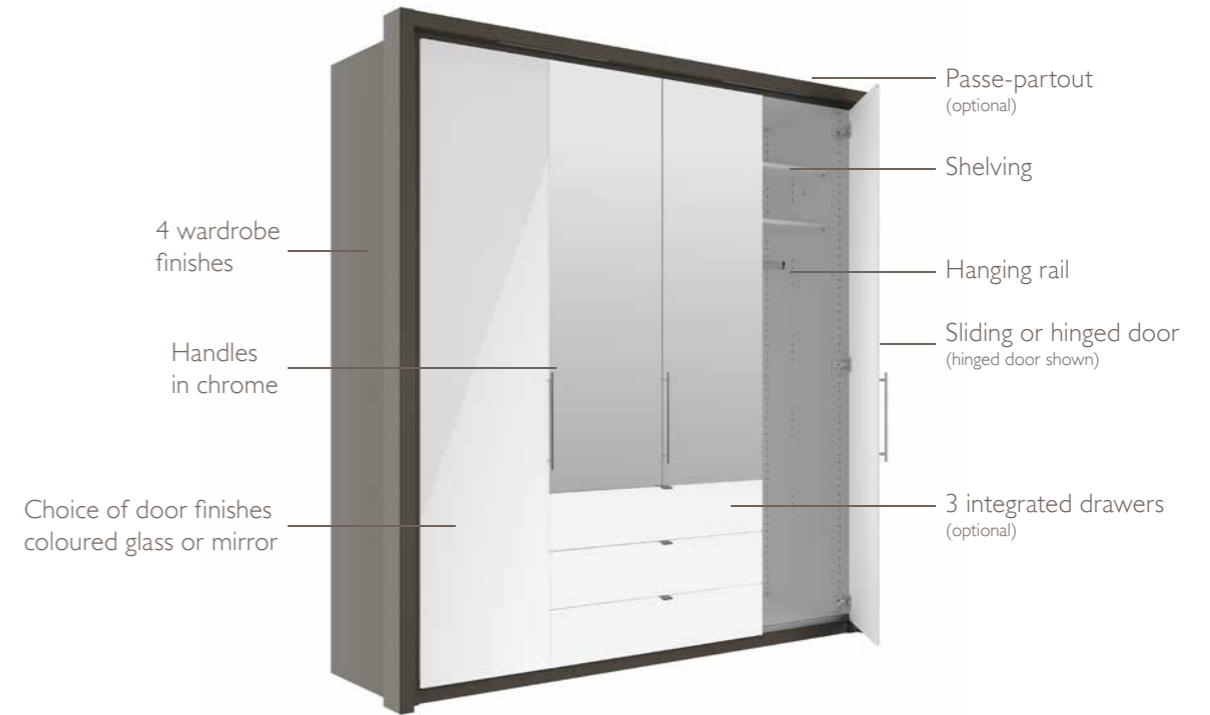

Wardrobe finishes

Door finishes

Choose from the available finishes below to match your bedroom style



Matt white

Havana

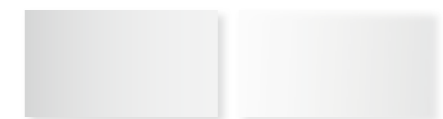

Mirror

White glass

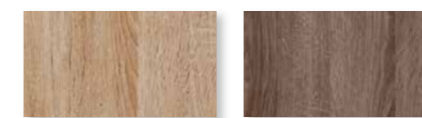

Light rustic oak

Dark rustic oak



Black glass

Magnolia glass

Available sizes

Hinged door wardrobes – these have a depth of 58cm

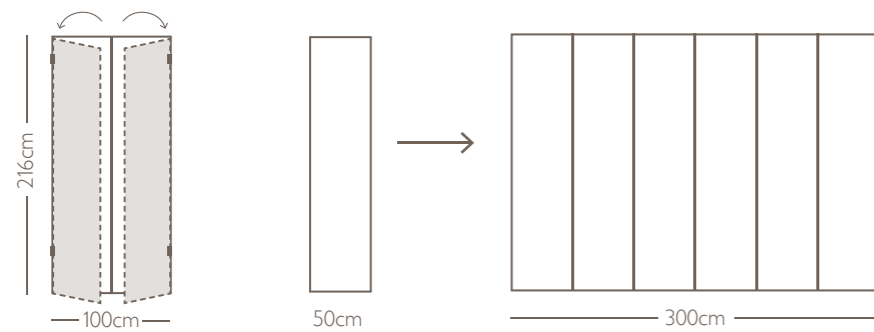

Available in widths of 50cm, 100cm, 150cm, 200cm, 250cm and 300cm

Sliding door wardrobes – these have a depth of 67cm

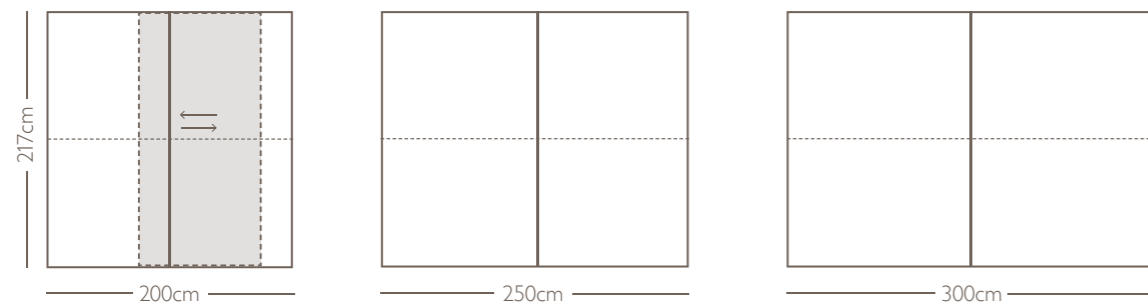

Door combinations

Door finishes can be combined in different ways when choosing your wardrobe. Examples shown below

Hinged door

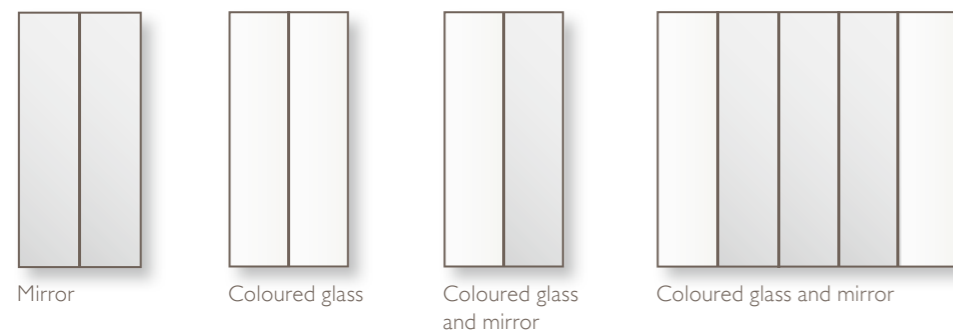

Sliding door

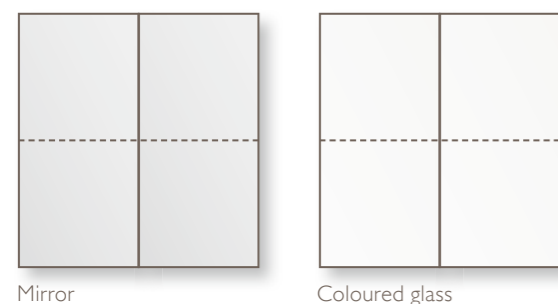

Hinged door with drawers

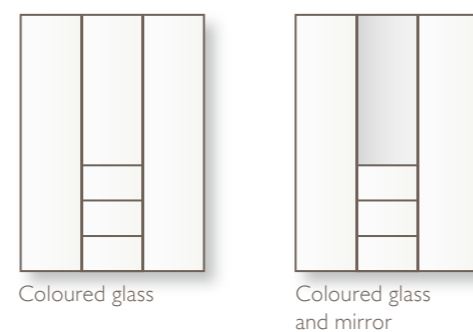

More options available, please speak to a store partner for more information

Choose your accessories

Maximise storage with additional shelves, rails, drawers and internal accessories.

Finish off your wardrobe with a cornice or a passe-partout frame

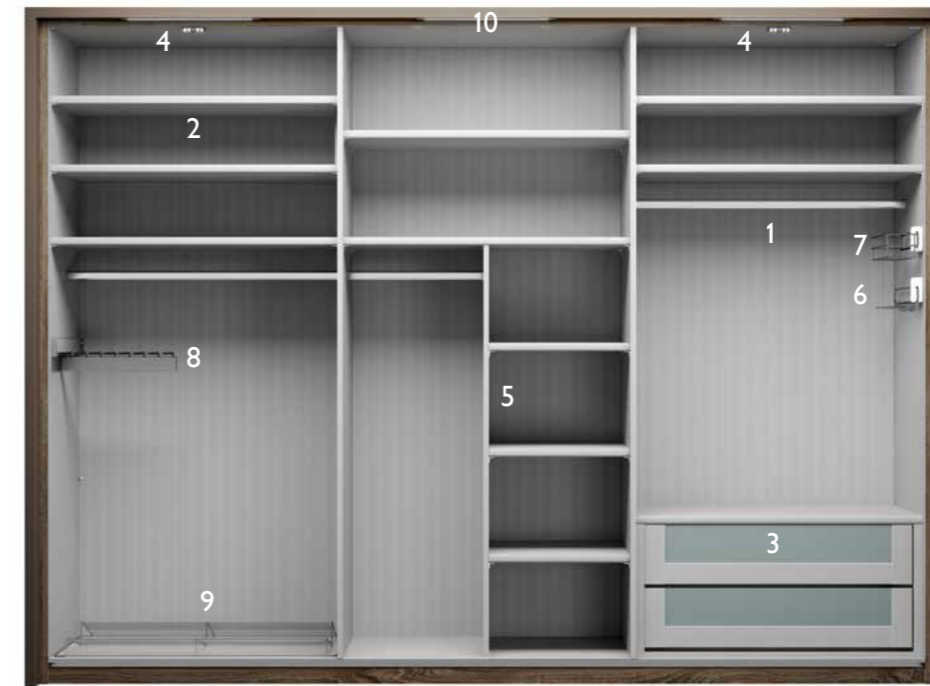

1. Additional hanging rails
2. Additional shelves
3. Set of 3 internal drawers with pinstripe finish fronts
4. Set of internal LED lights with motion detector
5. Internal laundry shelf insert
6. Tie and belt pull-out
7. Utensil pull-out
8. Pull-out trouser holder
9. Shoe rack
10. Passe-partout frame – with or without LED lighting (shown with lights)

Not all accessories will fit the internal dimensions of all wardrobes; please ask a partner in store for further information

Complete your bedroom

Choose matching furniture below (shown in havana with white glass)



Bed
Double W151 x L208cm
King W171 x L218cm
Super king W191 x L218cm

Bedside cabinet
2 drawers
W60 H37 D42cm

Bedside cabinet
3 drawers
W60 H53 D42cm

Chest of drawers
4 drawers
W75 H82 D42cm

Chest of drawers
4 drawers
W149 H82 D42cm

Other finishes available

Chest and bedside finishes

Drawer finishes

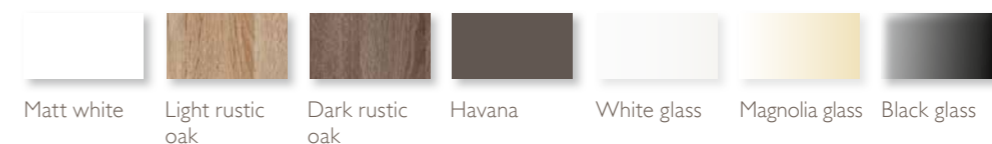

Pirna

The Pirna range gives true flexibility due its bi-fold doors that can be full length, or combined with integrated drawers. Its unique corner unit can be used to maximise storage



Key features

All wardrobes in the range come with two shelves and a hanging rail per internal compartment



Wardrobe finishes

Door finishes

Choose from the available finishes below to match your bedroom style



Matt white

Havana

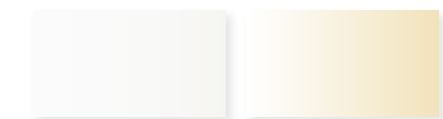

White glass

Magnolia glass



Rustic oak



Bronze mirror

Available sizes

Bi-fold door wardrobes – these have a depth of 58cm

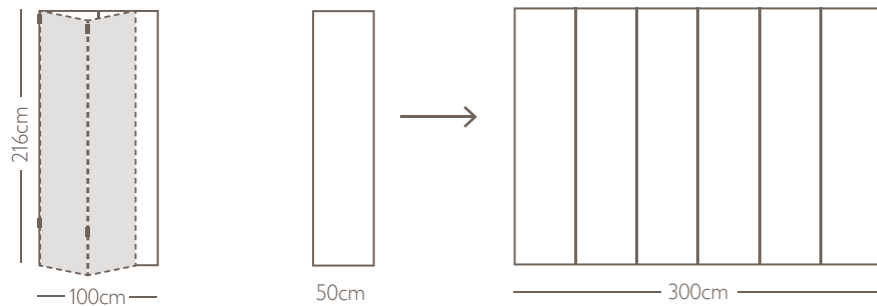

Available in widths of 50cm, 100cm, 150cm, 200cm, 250cm and 300cm

Corner units - optional to increase your storage space

Extended corner unit

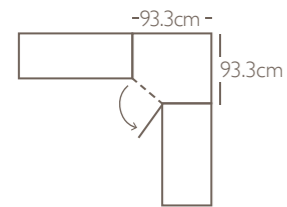

Walk-in corner units

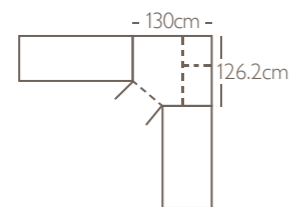

Door combinations

Door finishes can be combined in different ways when choosing your wardrobe. Examples shown below

Bi-fold door

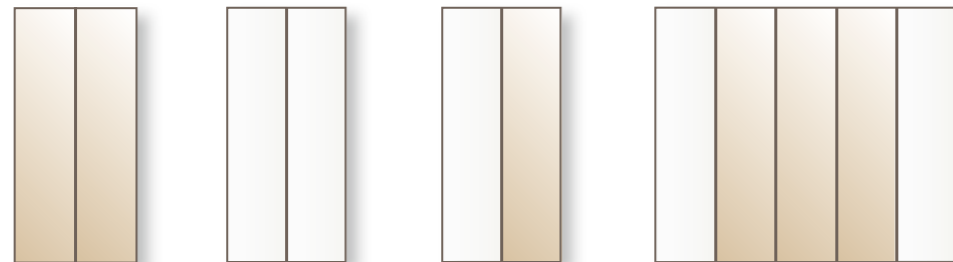

Bronze mirror

Coloured glass

Coloured glass and bronze mirror

Coloured glass and bronze mirror

Bi-fold door with draw combinations

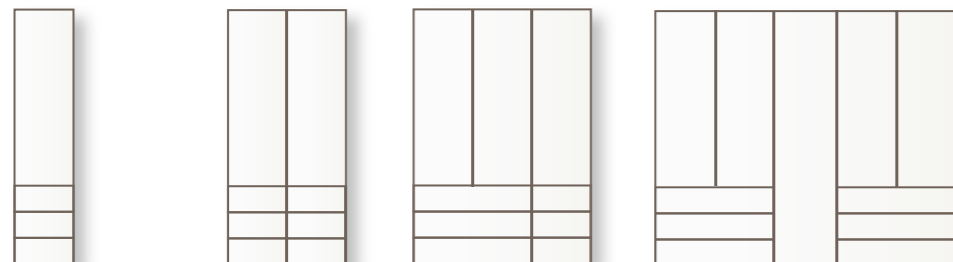

Coloured glass

Coloured glass

Coloured glass

Coloured glass

More options available, please speak to a store partner for more information

Choose your accessories

Maximise storage with additional shelves, rails, drawers and internal accessories.

Finish off your wardrobe with a cornice or a passe-partout frame

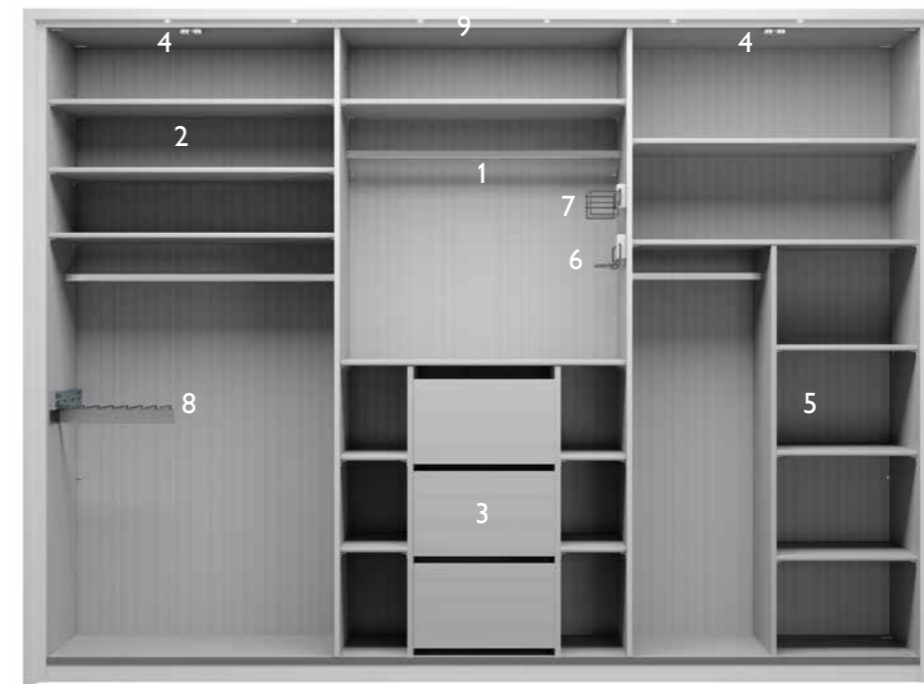

1. Additional hanging rails
2. Additional shelves
3. Set of 3 internal drawers with pinstripe finish fronts
4. Set of internal LED lights with motion detector
5. Internal laundry shelf insert
6. Tie and belt pull-out
7. Utensil pull-out
8. Pull-out trouser holder
9. Passe-partout frame – with or without LED lighting (shown with lights)
10. Cornice with or without LED lighting (not shown on image)

Not all accessories will fit the internal dimensions of all wardrobes; please ask a partner in store for further information

Complete your bedroom

Choose matching furniture below (shown in havana with white glass)



Bed
Double W151 x L208cm
King W171 x L218cm
Super king W191 x L218cm



Bedside cabinet
2 drawers
W60 H37 D42cm



Bedside cabinet
3 drawers
W60 H53 D42cm



Chest of drawers
4 drawers
W75 H82 D42cm



Chest of drawers
4 drawers
W149 H82 D42cm

Other finishes available

Chest and bedside finishes



Matt white

Rustic oak

Havana

Drawer finishes



White glass

Magnolia glass

Jena

The Jena range creates a real statement thanks to its unique dual-depth compartments and bi-fold doors. Its internal features mean every inch of space is optimised



Key features

All wardrobes in this range come with two shelves and a hanging rail per internal compartment



Wardrobe finishes

Door finishes

Choose from the available finishes below to match your bedroom style



Matt white

Havana



White glass

Havana glass



Champagne

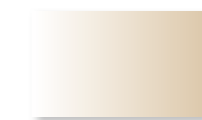

Bronze mirror

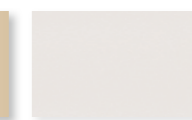

Champagne glass

Available sizes

All wardrobes have a maximum depth of 69cm, centre doors have a depth of 58cm

Bi-fold door

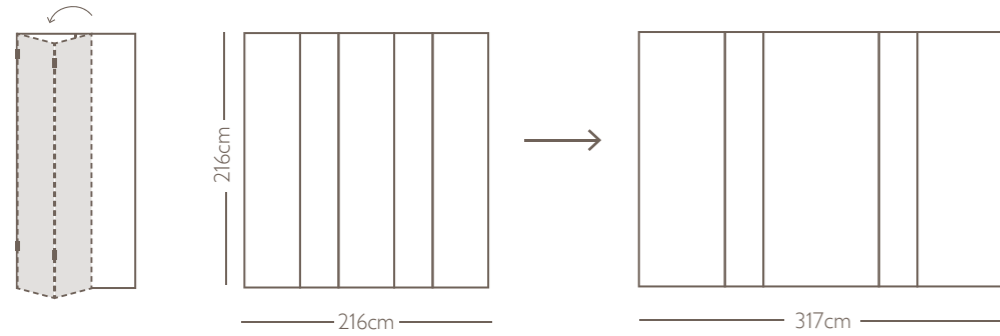

Available in widths of 219cm, 244cm, 268cm, 293cm and 317cm

Door combinations

Door finishes can be combined in different ways when choosing your wardrobe as shown below

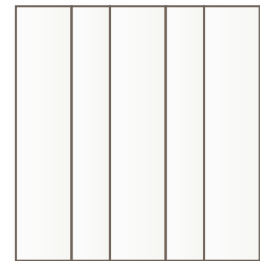

Coloured glass

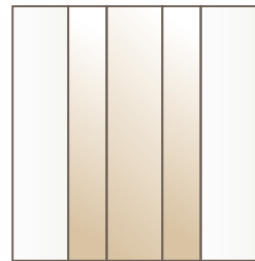

Coloured glass and bronze mirror

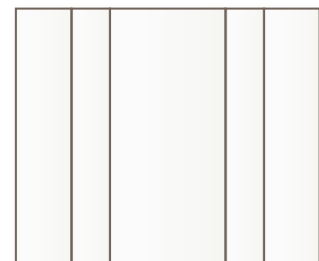

Coloured glass

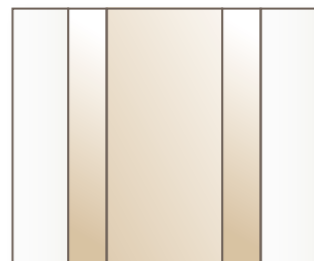

Coloured glass and bronze mirror

Choose your accessories

Maximise storage with additional shelves, rails, drawers and internal accessories.
Finish off your wardrobe with passe-partout frame

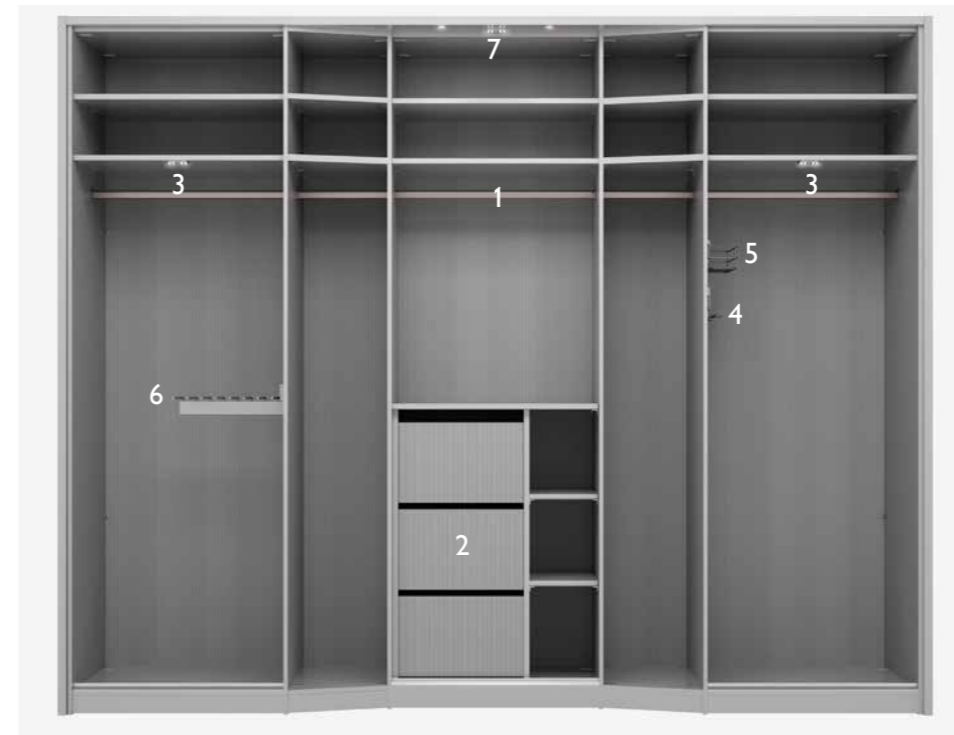

1. Additional hanging rails
2. Set of 3 internal drawers with pinstripe finish front
3. Set of internal LED lights with motion detector
4. Tie and belt pull-out
5. Utensil pull-out
6. Pull-out trouser holder
7. Passe-partout frame - with or without LED lighting (shown with lights)

Not all accessories will fit the internal dimensions of all wardrobes; please ask a partner in store for further information

Complete your bedroom

Choose matching furniture below (shown in champagne with havana glass)



Bed
Double W151 x L208cm
King W171 x L218cm
Super king W191 x L218cm



Bedside cabinet
3 drawers
W40 H64 D43cm



Chest of drawers
5 drawers
W60 H86 D43cm



Chest of drawers
5 drawers
W141 H86 D43cm

Other finishes available

Chest and bedside finishes



Matt white Champagne Havana

Drawer finishes



White glass Champagne glass Havana glass

Shop locations

London

Oxford Street
Brent Cross
Croydon
Heathrow
Kingston upon Thames
Peter Jones, Sloane Square
Stratford

England

Ashford
Basingstoke
Birmingham
Bluewater
Cambridge
Cheadle
Chelmsford
Cheltenham
Chester
Chichester
Cribbs Causeway
Exeter
High Wycombe
Horsham
Ipswich
Leeds
Leicester
Liverpool
Milton Keynes
Newbury
Newcastle
Norwich
Nottingham
Oxford
Peterborough
Poole
Reading
Sheffield
Solihull
Southampton
Swindon
Tamworth
Trafford
Tunbridge Wells
Watford
Welwyn
York

Scotland

Aberdeen
Edinburgh
Glasgow

Wales

Cardiff



John Lewis Partnership
171 Victoria Street
London SW1E 5NN
johnlewis.com

WDBRO/08.19

John Lewis
in store | online | mobile