

Lasko wardrobe

Instruction

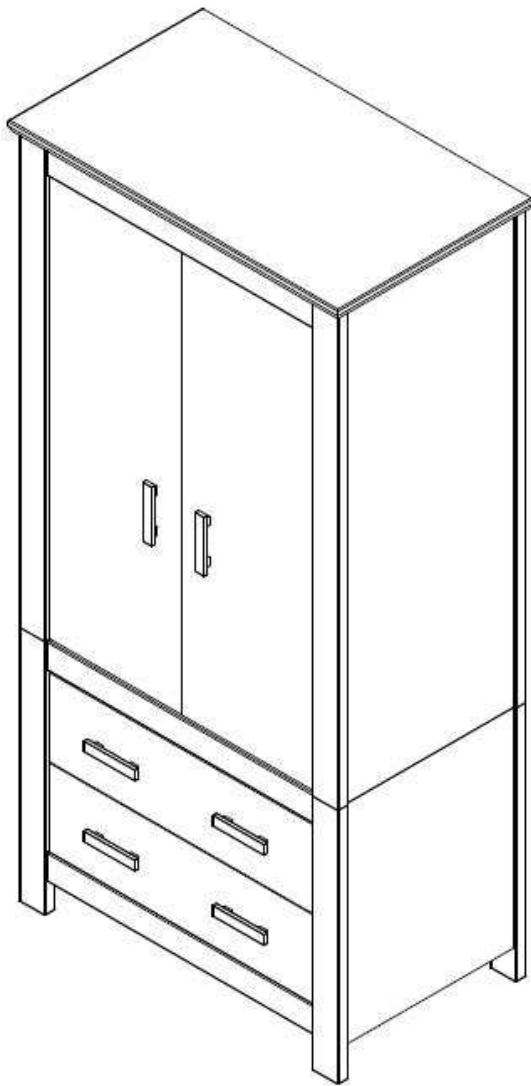

John Lewis

IMPORTANT
RETAIN FOR FUTURE REFERENCE
PLEASE READ CAREFULLY

Thank you for purchasing this Lasko wardrobe. Please read the instructions and warnings carefully before use to ensure safe and satisfactory operation of this product.





Your child's safety is your responsibility. If you have a query with this product or require replacement parts, please contact your nearest John Lewis department store.

Lay out the parts on a soft level surface and compare to the part/fixings checklist on pages 2 & 3. Do not discard any packaging until you are sure that you have all the parts.

Ensure that your child is kept clear during assembly due to small parts.

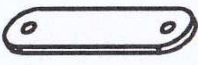
This product complies with BS 4875-7 and BS EN 14749 Clause-6.6 .

Fixings

<p>1</p>  <p>Handle bolt x 12</p>	<p>2</p>  <p>Metal bracket A x 2</p>	<p>3</p>  <p>Screws x 6</p>
<p>4</p>  <p>Metal bracket B x 1</p>	<p>5</p>  <p>Raw Plug x 1</p>	<p>6</p>  <p>Screw x 1</p>

Please note: raw plug and screw supplied is for Brick or Masonry only.

Wall fixing - if in doubt seek professional advice

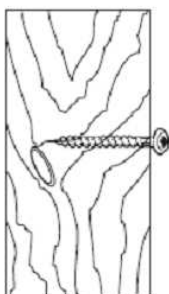

Wood

If fixing to wood make sure that it isn't chipboard as screws can easily pull away from the core structure

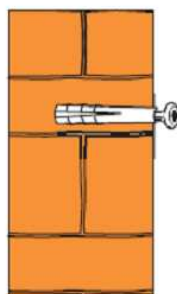

Brick or Masonry

Use an appropriate wall plug provided you are sure your wall is sound

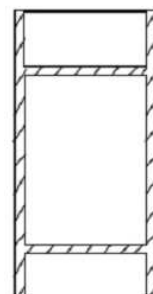

Cavity wall

Special toggle wall plugs are needed. Seek expert advice

A Upper part
B Lower part

C

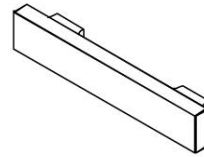
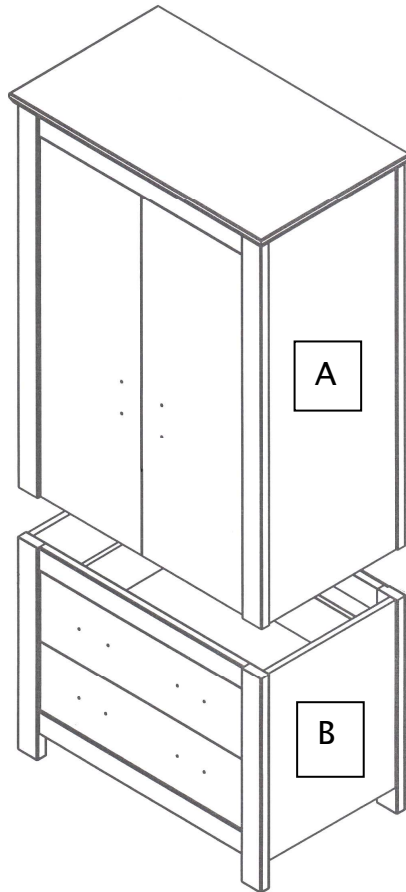

Handles x 6

You will need:

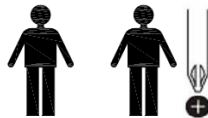

1 x cross head screwdriver

This product is **heavy**, it should be assembled as near as possible to the point of use.
Take care when lifting to avoid personal injury and (or) damage to the product.

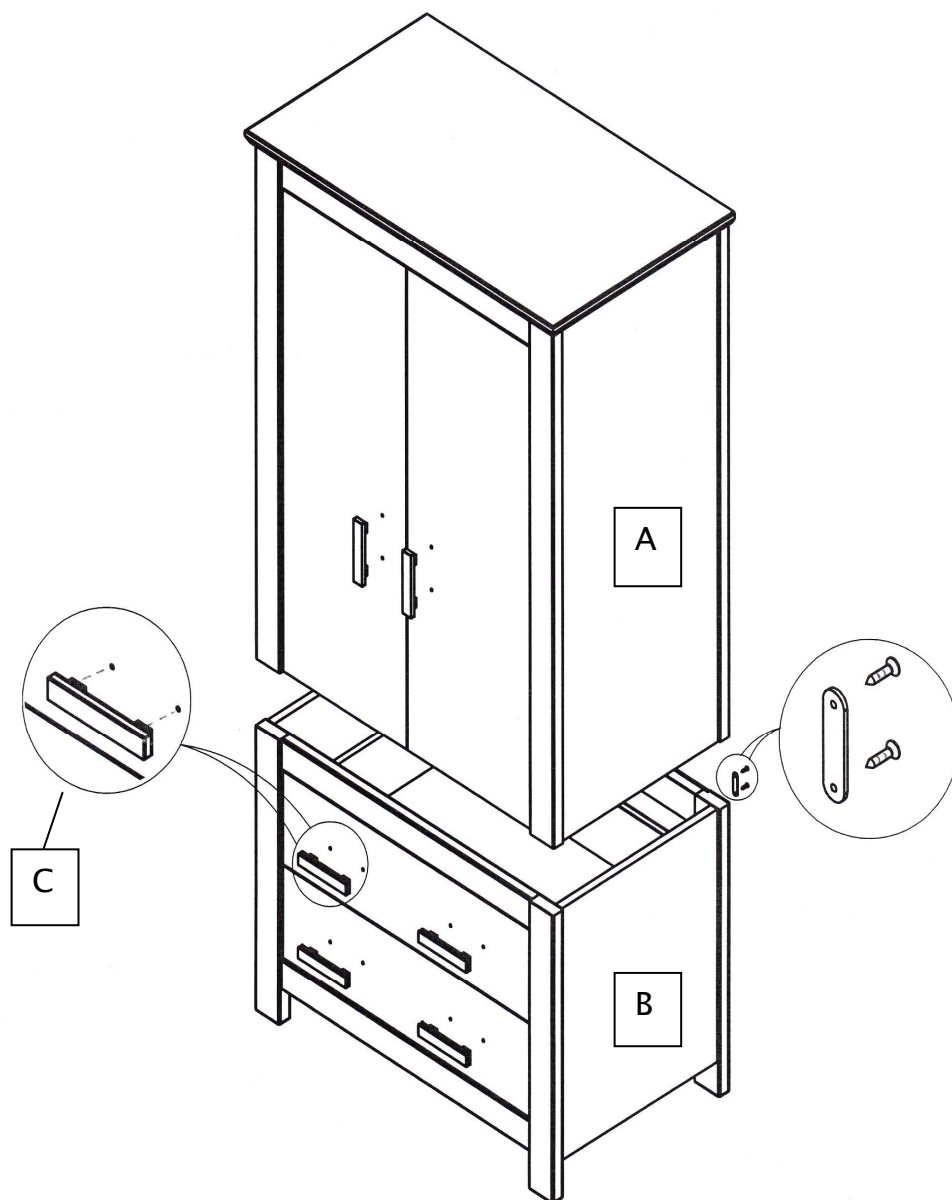

Step 1

Carefully lower Upper part A onto Lower part B, ensuring columns are aligned.

Step 2

Fixing 2x2

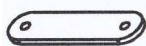

Fixing 3x4



To secure units together, screw the metal bracket A (fixing 2) using the two screws (fixing 3) to each back lower and upper column.

Step 3

Fixing 1x12



Using Handle Bolts (fixing 1), fix handles (part C) to wardrobe doors and drawers.

Step 4

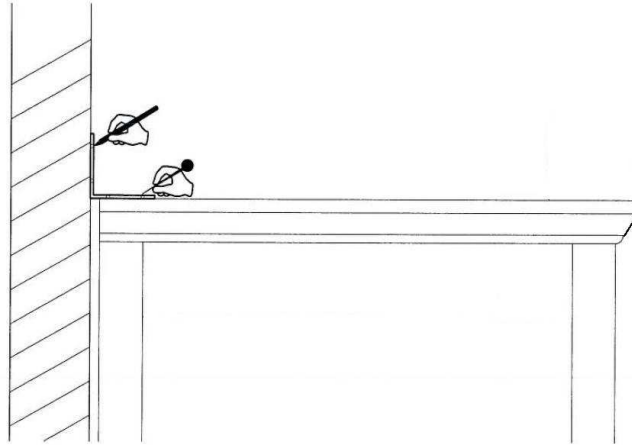

Using two people, carefully position wardrobe with back facing the wall in its intended position. Place the bracket (fixing 4) in position as shown in the top rear central edge so that the bracket is sitting at 90° against wall and top of wardrobe. Mark the hole position of the bracket (fixing 4) using bradawl or pencil for the top of the wardrobe and a pencil for the wall.

Step 5

Fixing 3x2



Fixing 4x1



Fixing 5x1



Fixing 6x1

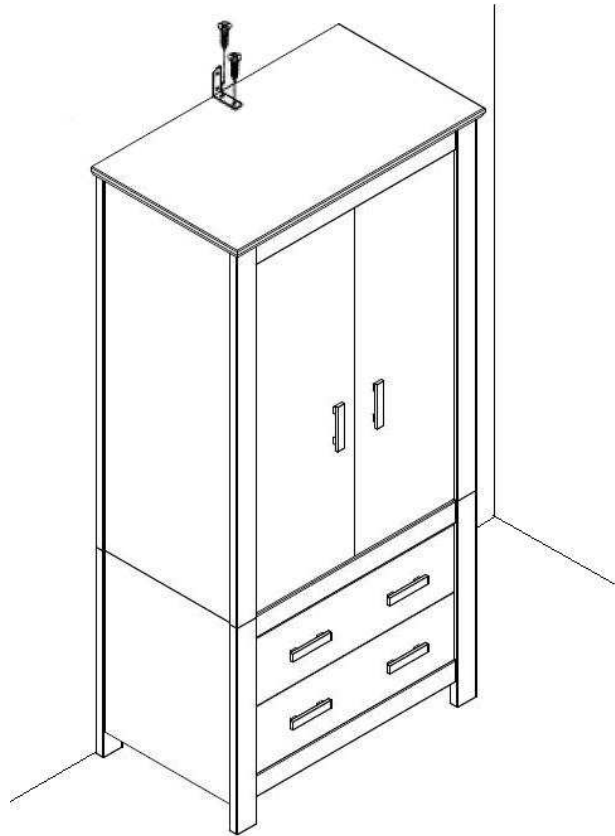

Drill and insert wall fixings into the wall.

Position 2x screw (fixing 3) in the marked positions as shown and first tap the top of the screws with a hammer to mark the centre point then use a screwdriver to fix the bracket B (fixing 4) in place firmly. Fix the bracket (fixing 4) to the wall using the appropriate screws for wall type.

Please note: if the bracket (fixing 4) cannot be firmly secured due to the large space between wardrobe and wall you may have to purchase a separate suitable fixing kit.

Care and maintenance

Your furniture may be cleaned by wiping with a damp cloth and drying with a soft clean cloth.

Do not use abrasives, bleach, alcohol or ammonia-based household polishes.

Take care when handling or moving the furniture.

Wood Furniture

Wood displays different grain patterns depending on which way they cut – for example, the ‘medullary ray’ which can appear on oak furniture is a mark of good quality timber – these are just characteristics of the natural beauty of the wood. Some furniture is also deliberately aged or rustic.

Wood veneers also allow distinctive patterns to be created on flat surfaces, such as table tops or drawer fronts by the way the slivers are arranged.

All timber surfaces will change colour and mellow over time. New furniture will initially vary in shade from items that have previously purchased.

Safety notes

Periodically check all fixings to ensure none have come loose and that there is no risk of clothing or parts of the body becoming snagged or trapped.

Furniture can be dangerous if incorrectly installed. Assembly should be carried out by a competent person.

Keep children clear during assembly as pack contains small parts which may present a choking hazard.

Do not allow your child to climb on this furniture.

Be aware of the risk of open fires and other such sources of strong heat, such as electric bar fires, gas fires, etc in the vicinity of the wardrobe.

Do not use this wardrobe if any components are missing or damaged.